

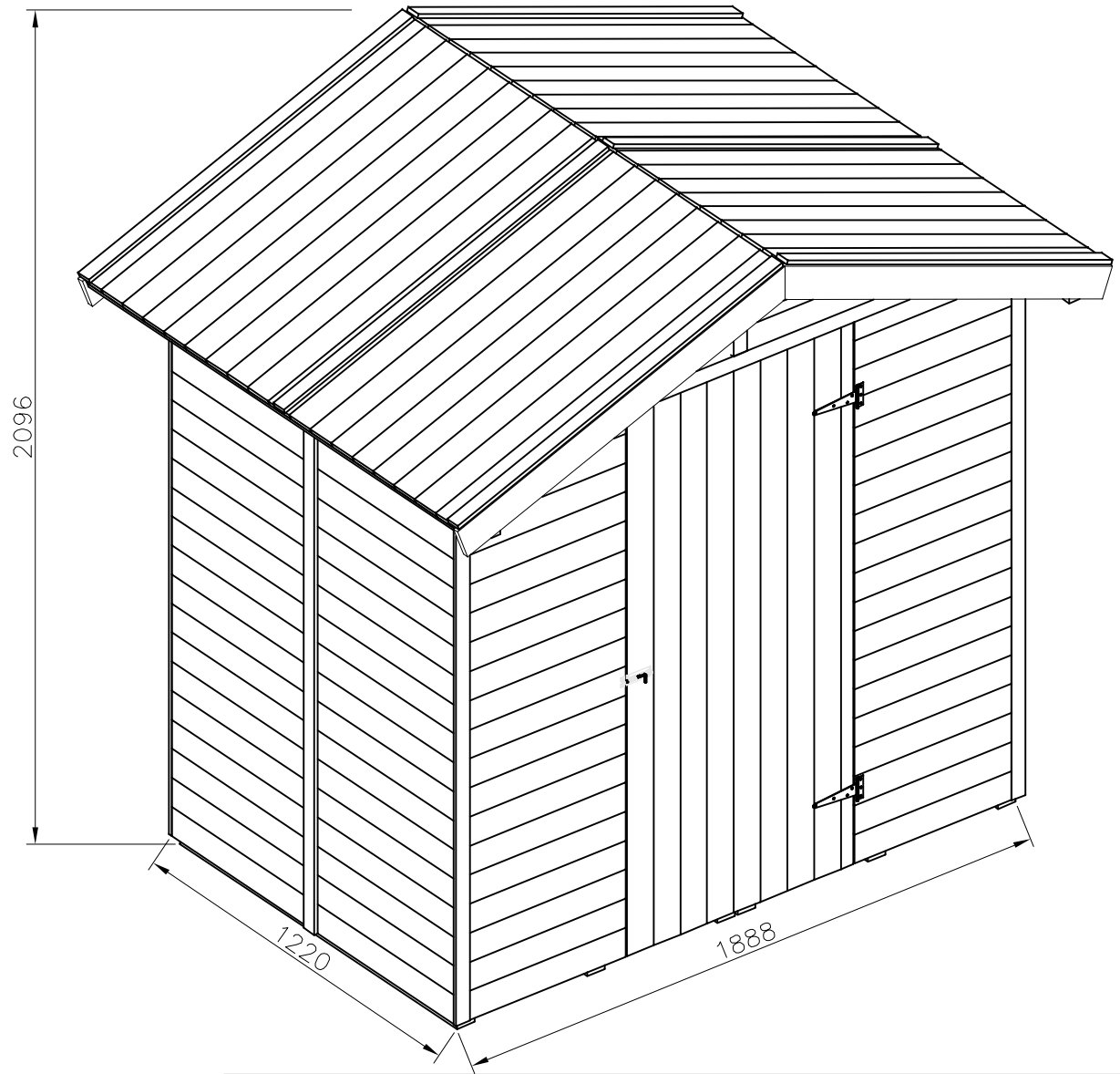

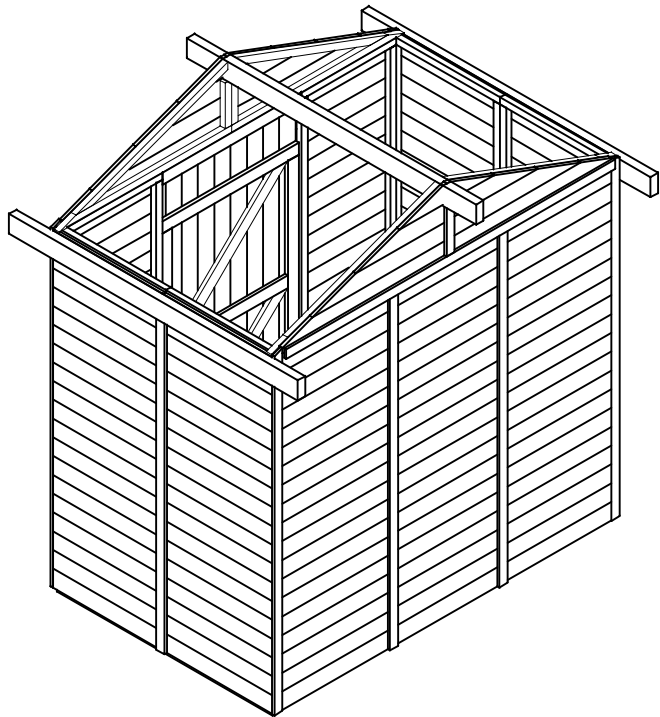

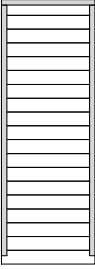







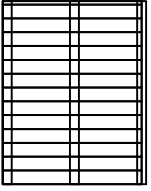
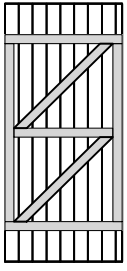

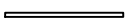













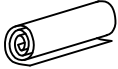
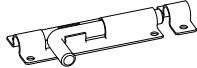
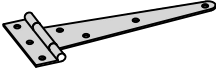



TUINDECO

LEADING IN GARDEN PRODUCTS

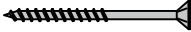

Name	Vincent 188x122; 16		
Zeichnung/ Drawing	3D	Kunde/ Client	
Profil/ Profile	1.6x8.9	Datum/ Date	14.12.2022

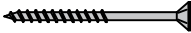
Pos	Teieliste/Specification Vincent 188x122; 16		Stck Pcs.	Profil Profile (mm)	Länge Length (mm)
EL1			7	600x1702	
EL2			2	520x1702	
EL3			2	944x356	
EL4			2	944x356	
FL1			2	923x1178	
DR1			1	753x1661	
LT6		LATTEN - STUDS ELEMENT 1	7	34x28	600
LT7		LATTEN - STUDS ELEMENT 2	2	34x28	520
LT10		LATTEN (TÜR) - STUDS (DOOR)	1	58x28	760
LE4		LEISTE - LATH ✓	1	58x16	1178
LE8		LEISTE - LATH ✓	2	45x12	1800
LE1		LEISTE - LATH ✓	4	45x12	1718
LE3		LEISTE - LATH ✓	2	45x12	1670
Kood	Vincent 188x122; 16		Materjal		Leht 1/2

Pos	Teieliste/Specification Vincent 188x122; 16			Stck Pcs.	Profil Profile (mm)	Länge Length (mm)
LE6		LEISTE - LATH	✓	2	45x12	1600
LE5		LEISTE - LATH	✓	2	45x12	1580
LE7		LEISTE - LATH	✓	6	45x12	1150
LE2		LEISTE - LATH	✓	2	45x12	239
PF1		PFETTEN - PURLINS		3	40x95	1580
	DACHBRETTER - ROOF BOARDS		✓	36+1 28+1	89x16 113x16	1150
G01-1	GIEBELBRETTER - GABLE BOARDS 18x95	20.5° 	✓	4	18x95	1156
KP-1	DACHPAPPE - ROOFING FELT		✓		2,45m-2'st	4.9 lfm/rm
R03	RIEGEL - LATCH 03			1		
H02	T-SCHARNIER - T-HINGE 150mm KZN			2		
NG2 350	Vierkantnagel feuerverzinkt - Galvanized square nail 2.3x50 Dachbretter - Roof boards			144		
SR3 027	Schrauben - Screws 3.0x25 C3 Leiste LE5 - Lath LE5			6		
SR3 027	Schrauben - Screws 3.0x25 C3 Leiste LE7 - Lath LE7			18		
SR3 032	Schrauben - Screws 3.0x30 C3 Leiste LE4 - Lath LE4			4		
SR3 032	Schrauben - Screws 3.0x30 C3 Riegel - Latch 03			6		
SR3 542	Schrauben - Screws 3.5x40 C3 Giebelbretter - Gable boards			12		
SR3 542	Schrauben - Screws 3.5x40 C3 Leiste -Lath LE1,LE2,LE3,LE6,LE8			44		
SR4 032	Schrauben - Screws 4.0x30 C3 T-SCHARNIER - T-HINGE 150mm KZN			14		
SR4 062	Schrauben - Screws 4.0x60 C3 Studs LT6, LT7			18		
SR4 062	Schrauben - Screws 4.0x60 C3 Studs LT10			4		
SR4 062	Schrauben - Screws 4.0x60 C3 EL1-EL2 befestigung zu FL1			18		
SR4 062	Schrauben - Screws 4.0x60 C3 Elementen befestigung - El.fixing			36		
SR4 572	Schrauben - Screws 4.5x70 C3 PF1 befestigung - PF1 fixing			8		
	✓ - Bitte selber anpassen (falls nötig)! / Cut into length on site (if needed)!					
Kood	Vincent 188x122; 16			Materjal		Leht 1/2

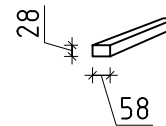
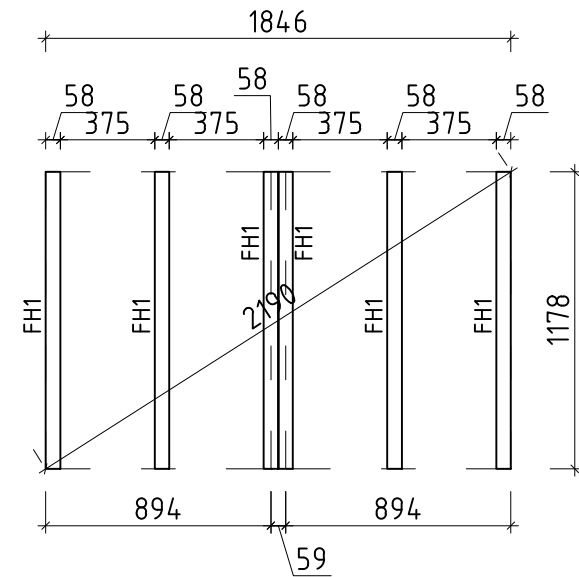
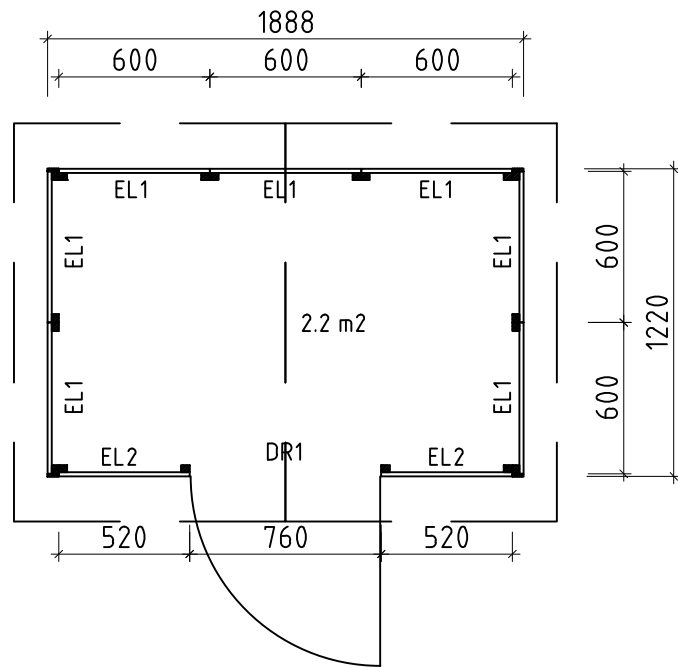

Name	Vincent 188x122; 16		
Zeichnung/ Drawing	Grundplan, Plan, Lagerholzplan, Foundation beams	Kunde/ Client	
Profil/ Profile	1.6x89	Datum/ Date	14.12.2022