

Name  
*Hugo 230x224; 16*









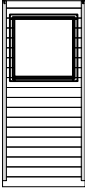

Zeichnung/  
Drawing  
*3D*



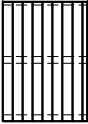
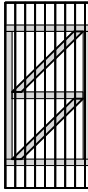
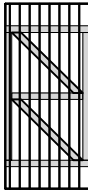
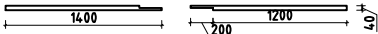
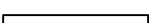
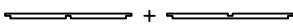















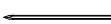



Kunde/  
Client

Profil/  
Profile  
*1.6x8.9*

Datum/  
Date  
*22.11.2022*

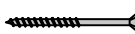
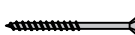

Pos	Teieliste/Specification Hugo 230x224; 16		Stck. Pcs.	Profil Profile (mm)	Länge Length (mm)
EL1			8	740x1702	
EL2			1	740x1702	
EL3			2	350x1702	
EL4			2	1154x430	
EL5			2	1154x430	
FL1			6	756x1099	
DR1			1	753x1661	
DR2			1	753x1661	
PF1	 <p>PFETTEN - PURLINS</p>		2	40x95	1400
PF2	 <p>PFETTEN - PURLINS</p>		4	40x95	1300
PR01	  <p>SPROSSEN - MUNTINS</p>		1+1	18x18	554
LE10	 <p>LEISTE - LATH</p>		✓	2	58x16 1138
LE1	 <p>LEISTE - LATH</p>		✓	4	45x12 1718
LE2	 <p>LEISTE - LATH</p>		✓	2	45x12 1673
LE5	 <p>LEISTE - LATH</p>		✓	4	45x12 1600
Kood	Hugo 230x224; 16		Materjal		Leht 1/3

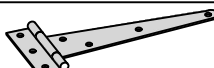
Pos	Teilleiste/Specification Hugo 230x224; 16		Stck. Pcs.	Profil Profile (mm)	Länge Length (mm)		
LE6		LEISTE - LATH	✓	8	45x12	1350	
LE4		LEISTE - LATH	✓	4	45x12	1300	
LE11		LEISTE - LATH	✓	4	45x12	1110	
LE3		LEISTE - LATH	✓	2	45x12	309	
LT10		LATTEN (TÜR) - STUDS (DOOR)	✓	1	58x28	1520	
LT4		LATTEN - STUDS		9	34x28	740	EL 1, 2
LT5		LATTEN - STUDS		2	34x28	350	EL - 3
	DACHBRETTER - ROOF BOARDS			60+1 48+1	89x16 113x16	1350	
G01-1	GIEBERBRETTER - GABLE BOARDS	 20.3°	✓	4	18x95	1360	
NG2 350	Vierkantnagel feuerverzinkt - Galvanized square nail 2.3x50 Dachbretter - Roof boards			240			
SR3 022	Schrauben - Screws 3.0x20 C3 - Sprossen - Muntins			4			
SR3 027	Schrauben - Screws 3.0x25 C3 - Leiste - Lath LE4			8			
SR3 027	Schrauben - Screws 3.0x25 C3 - Leiste - Lath LE6			24			
SR3 032	Schrauben - Screws 3.0x30 C3 - Leiste - Lath LE10			8			
SR3 032	Schrauben - Screws 3.0x30 C3 - Pfetten PF1 - Purlins PF1			4			
SR3 032	Schrauben - Screws 3.0x30 C3 - Riegel - Latch 03			6			
SR3 542	Schrauben - Screws 3.5x40 C3 - Giebelbretter - Gable boards 18x95mm			12			
SR3 542	Schrauben - Screws 3.5x40 C3 - Leiste - Lath LE1, LE2, LE3, LE5, LE11			52			
SR4 032	Schrauben - Screws 4.0x30 C3 - T-Scharnier - T-Hinge			28			
SR4 062	Schrauben - Screws 4.0x60 C3 - Latten - Studs LT4, LT5			22			
SR4 062	Schrauben - Screws 4.0x60 C3 - Latten - Studs LT10			4			
SR4 062	Schrauben - Screws 4.0x60 C3 - EL1-EL3 befestigung zu FL1			22			
SR4 062	Schrauben - Screws 4.0x60 C3 - Elementen befestigung - El.fixing			42			
SR4 572	Schrauben - Screws 4.5x70 C3 - PF2 befestigung - PF2 fixing			12			
H02	T-SCHARNIER - T-HINGE 150mm KZN			4			
Kood	Hugo 230x224; 16		Materjal		Leht	2/3	



# Aufbau Anleitung für/Installation guide for "Hugo 230x224; 16"

## 1. Fußboden/Floor

Leiste 16x58 LE10/  
Lath 16x58 LE10  
Bitte selber anpassen (falls  
nötig)! / Cut into length on  
site (if needed)!

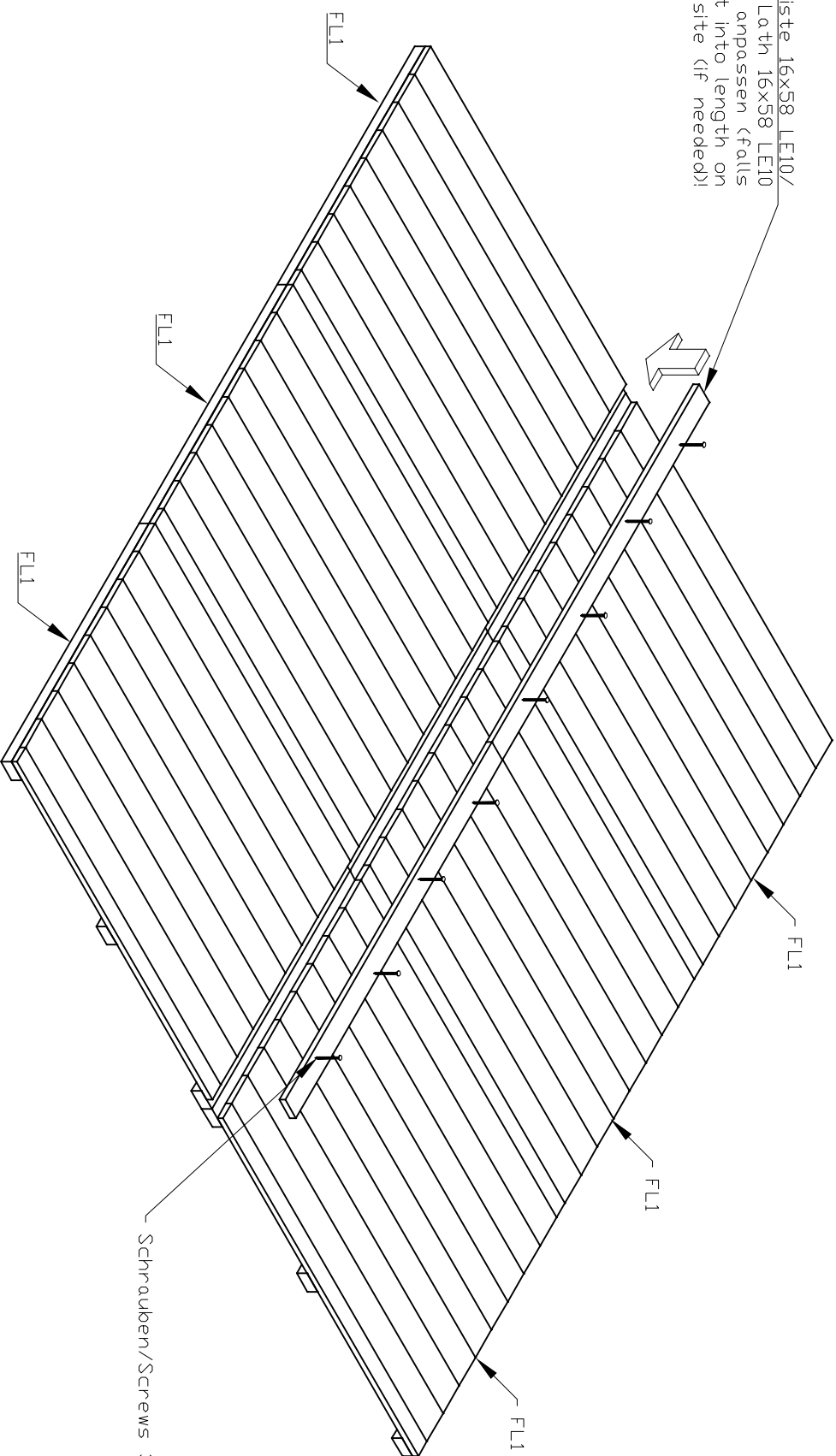

Schrauben/Screws 30x30 C3 x8

# Aufbau Anleitung für/Installation guide for "Hugo 230x224; 16"

## 2.1 Montage der Wandelemente / Assembly of wall elements

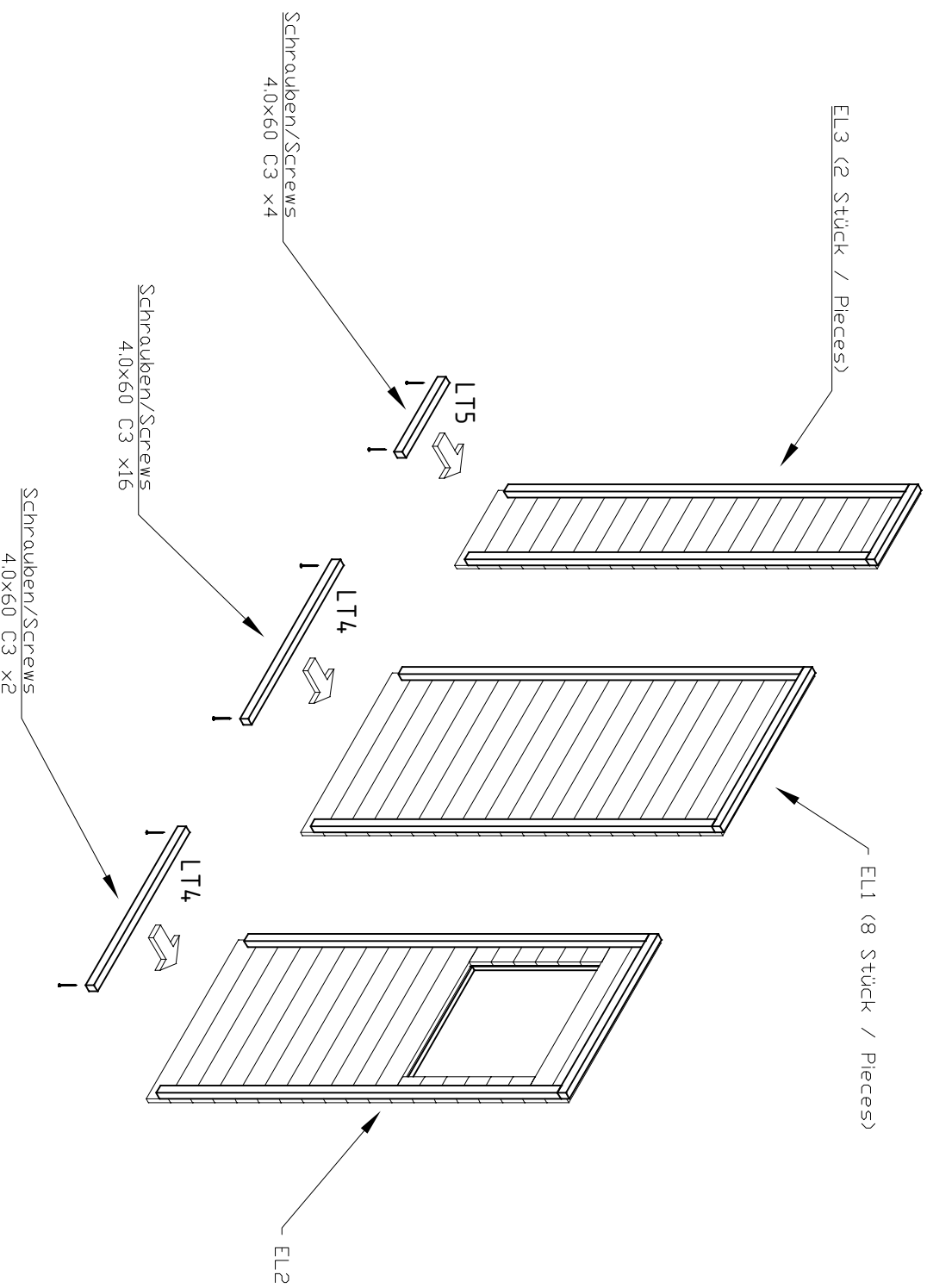

## Aufbau Anleitung für/Installation guide for "Hugo 230x224; 16"

### 2.2 Montage der Wandelemente / Assembly of wall elements

Das Wandelement an den Fundamentholz befestigen, nicht nur an den Fussbodenbretter! / Attach the wall elements to the foundation beams not only to the floorboards!

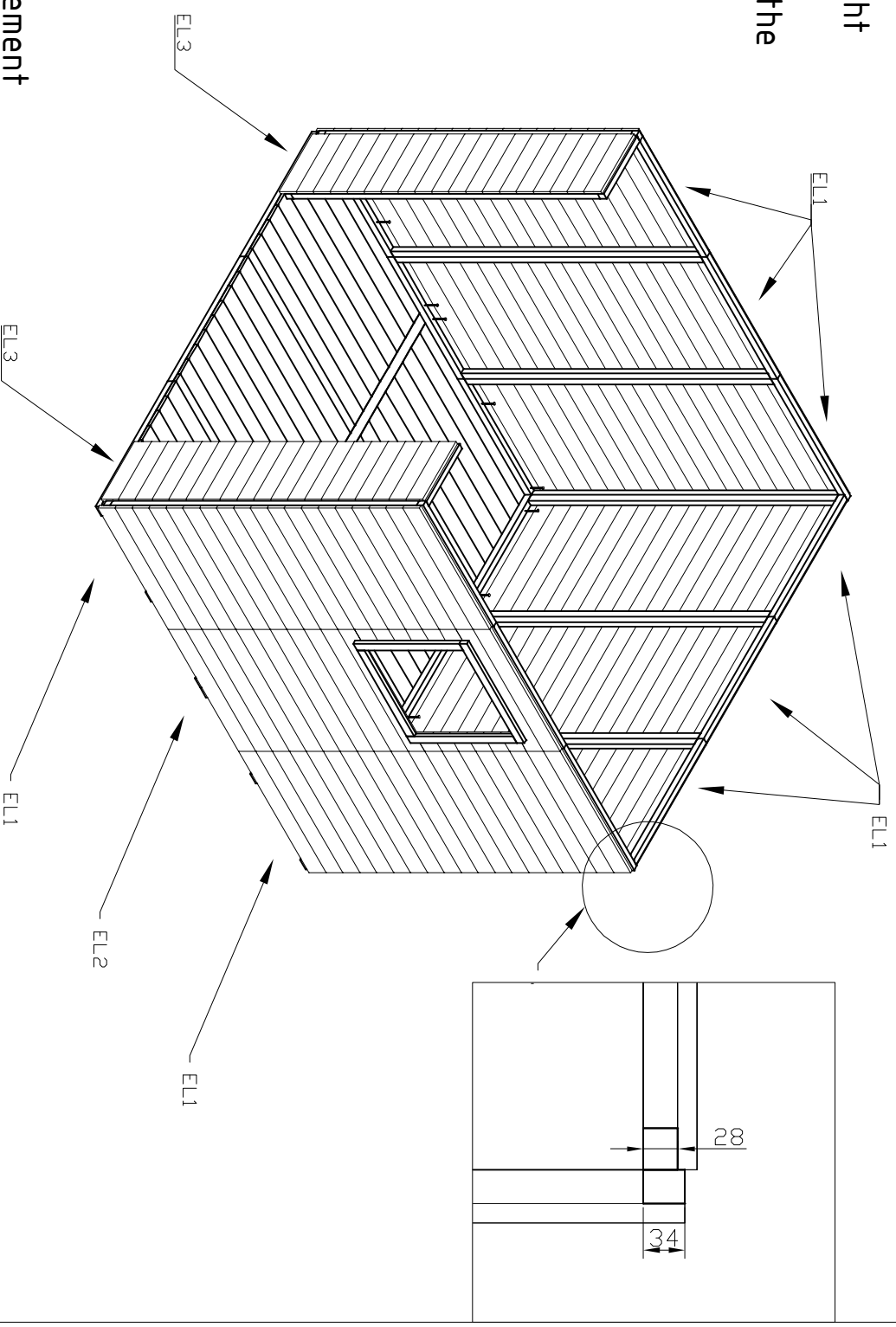

2 Schrauben 4.0x60 C3 für Element  
/ 2 Screws 4.0x60 C3 per element.



## Aufbau Anleitung für/Installation guide for "Hugo 230x224; 16"

### 2.3 Montage der Wandelemente / Assembly of wall elements

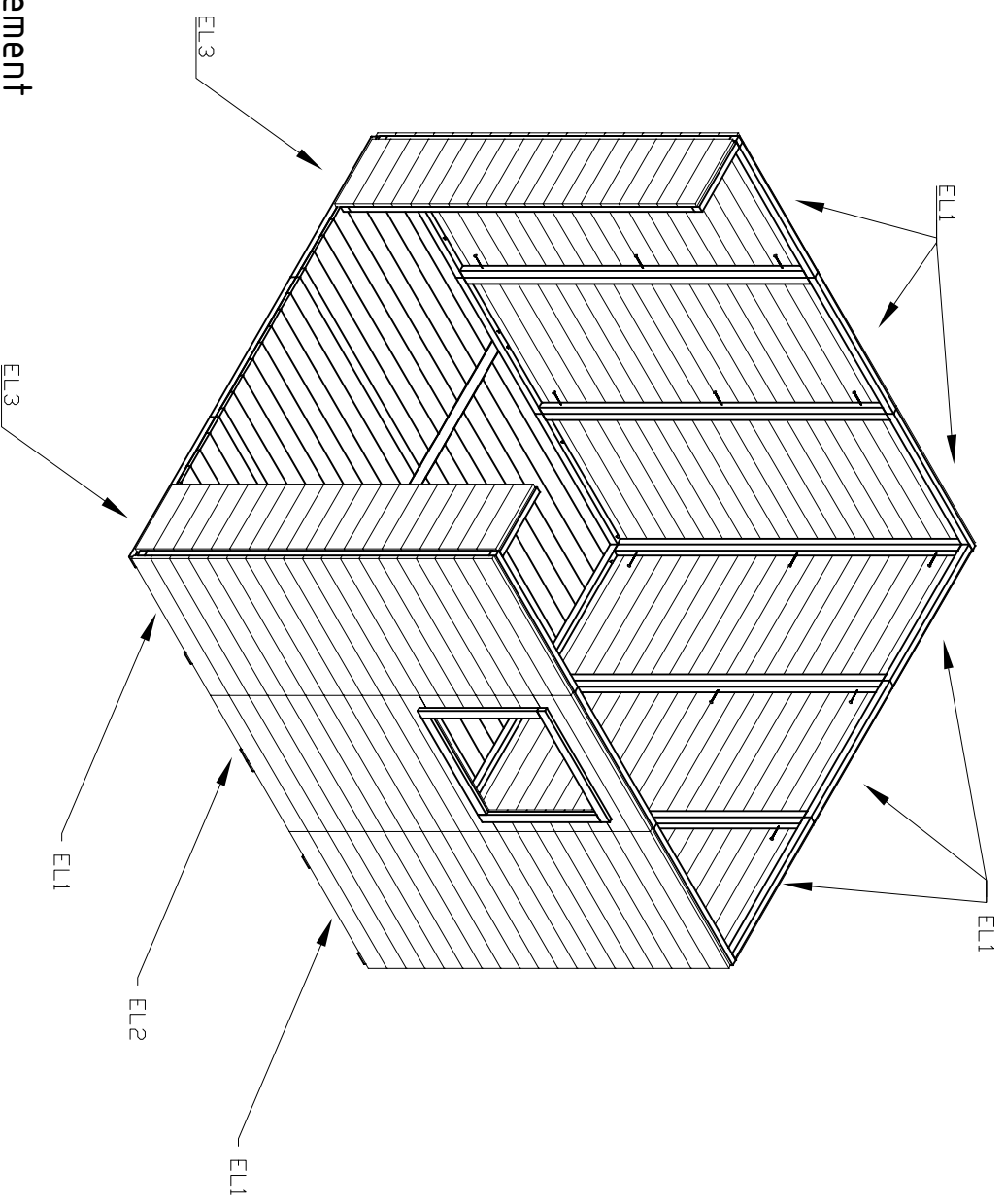

3 Schrauben 4.0x60 C3 für Element  
/ 3 Screws 4.0x60 C3 per element.

# Aufbau Anleitung für/Installation guide for "Hugo 230x224; 16"

## 2.4 Montage der Wandelemente / Assembly of wall elements

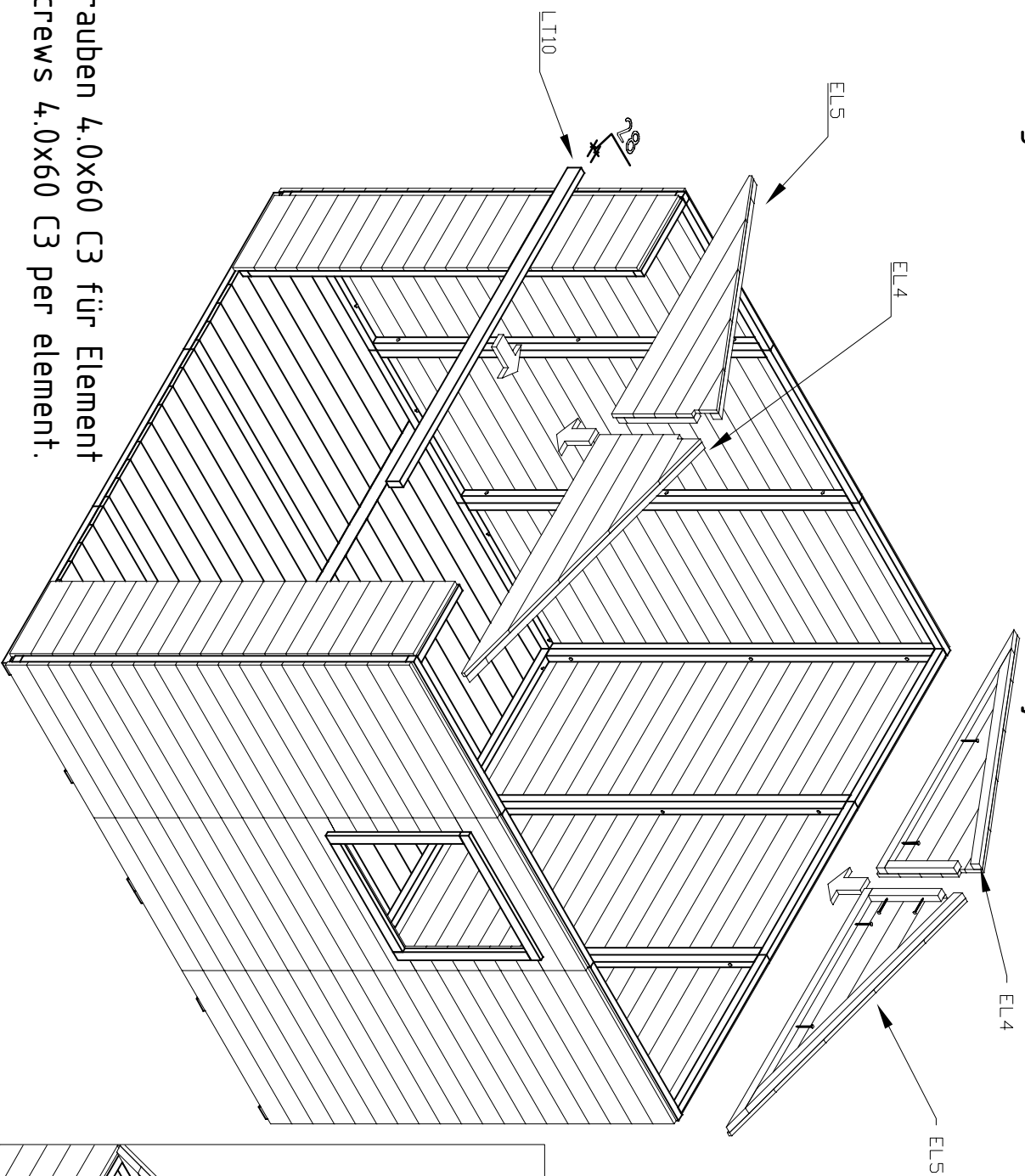

2 Schrauben 4.0x60 C3 für Element  
/ 2 Screws 4.0x60 C3 per element.

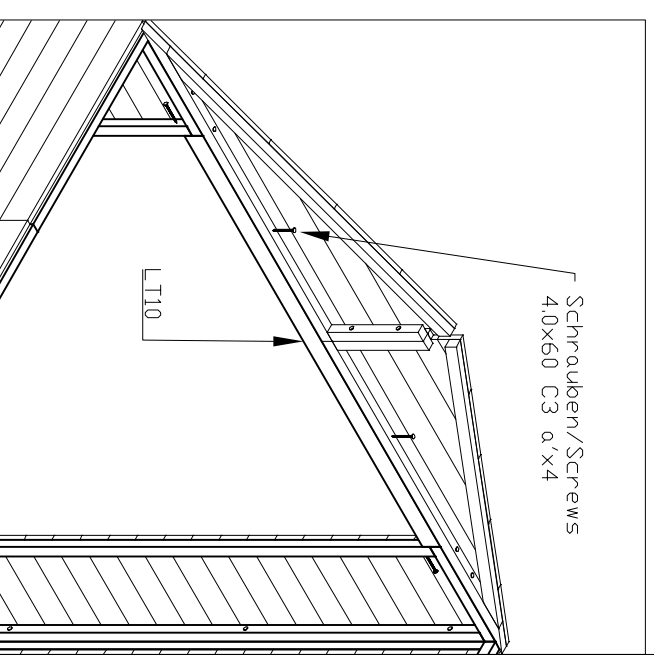

# Aufbau Anleitung für/Installation guide for "Hugo 230x224; 16"

## 3. Pfetten/Purlins

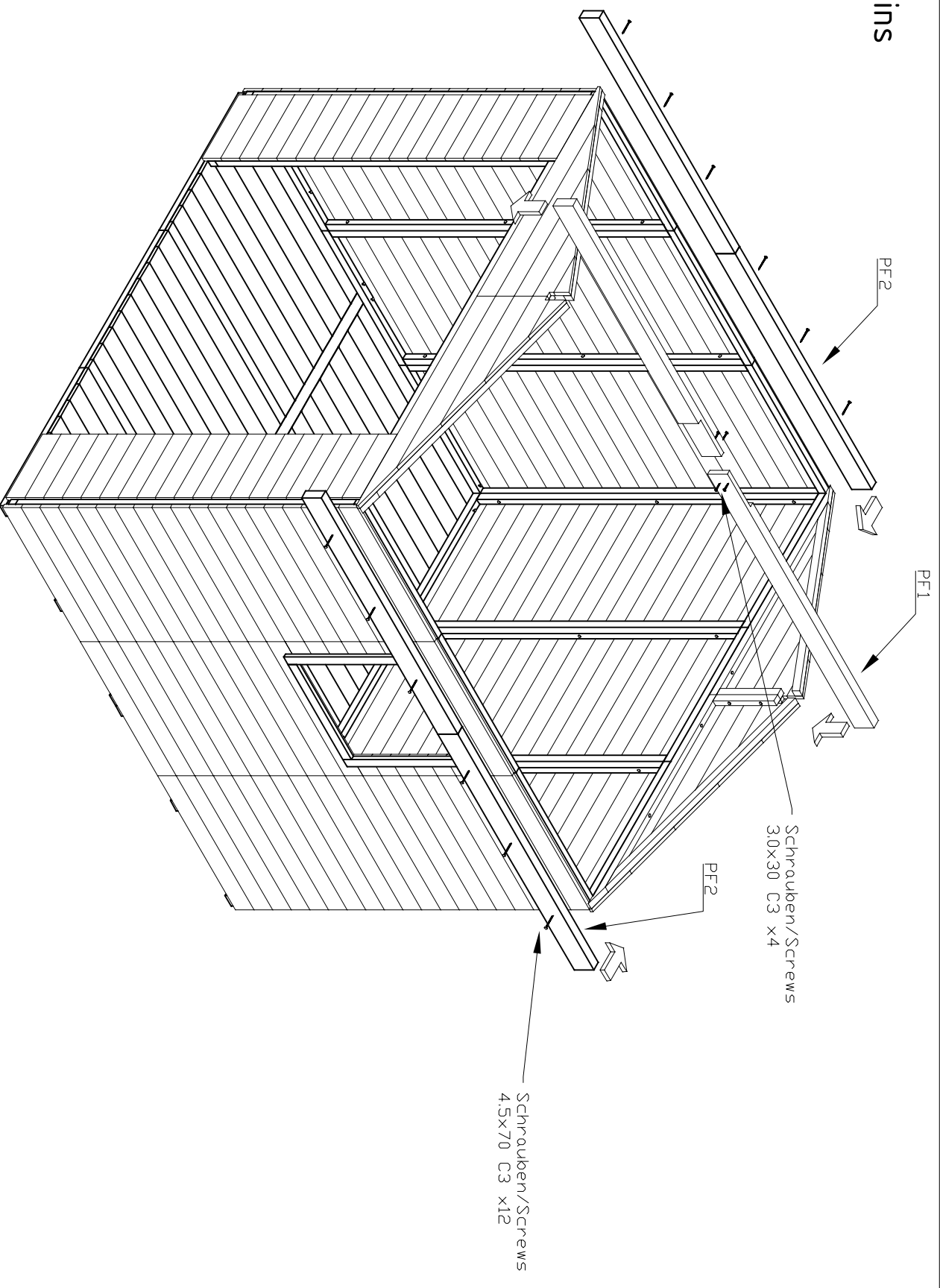

# Aufbau Anleitung für/Installation guide for "Hugo 230x224; 16"

## 4. Dachbretter/Roof boards

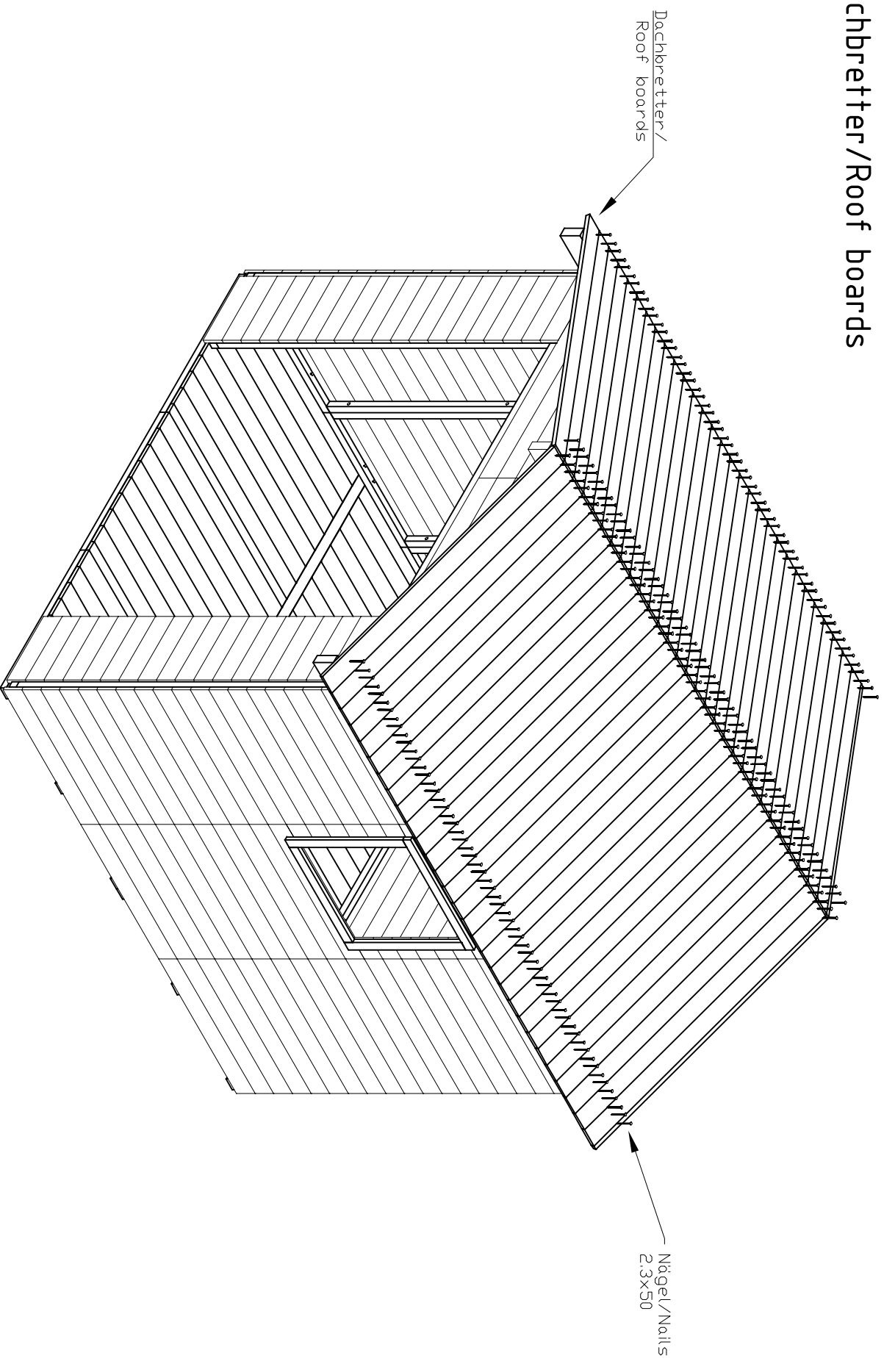

# Aufbau Anleitung für/Installation guide for "Hugo 230x224; 16"

## 5. Leisten (Dach)/Strips (Roof)

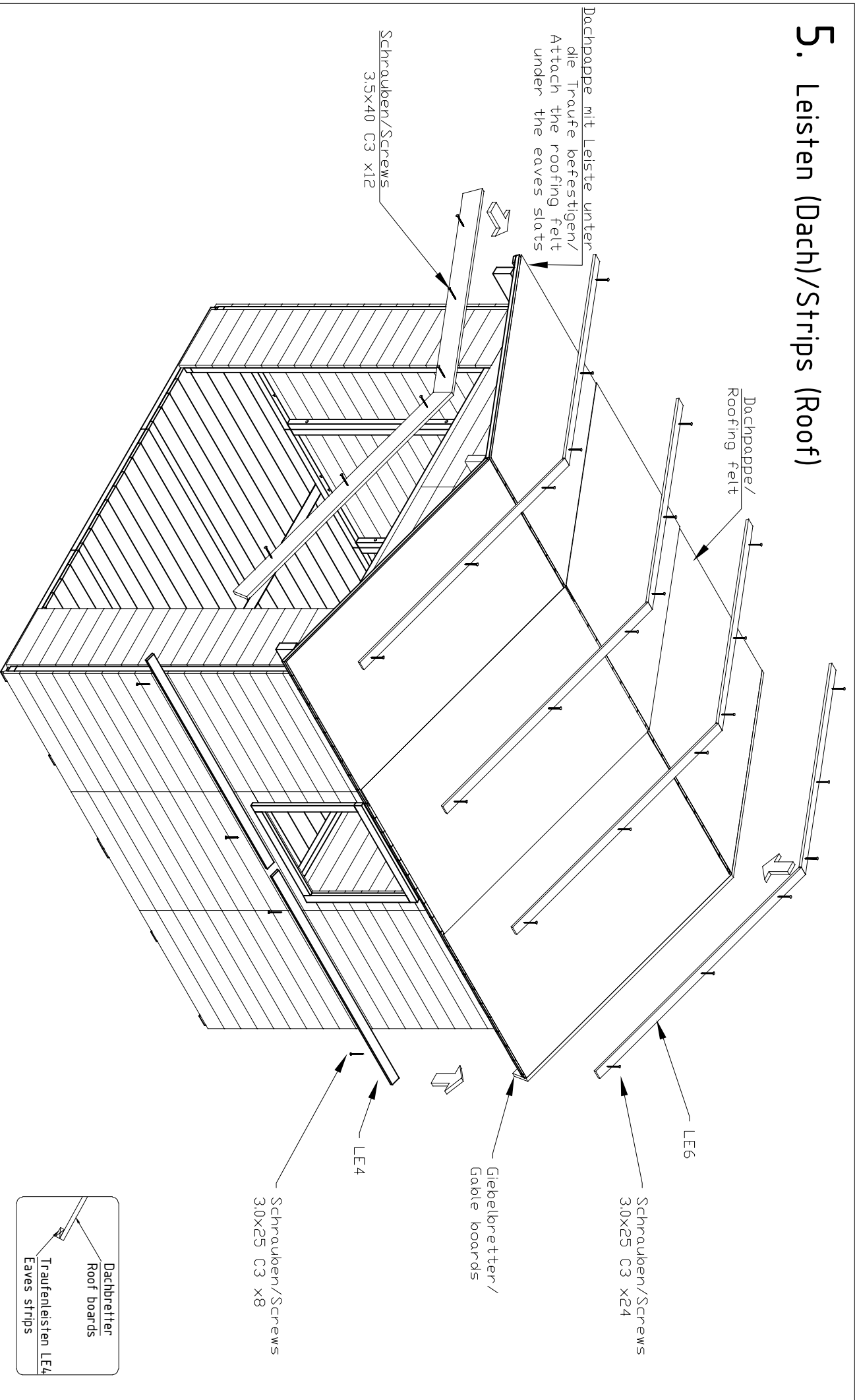

# Aufbau Anleitung für/Installation guide for "Hugo 230x224; 16"

## 6. Leisten/Strips

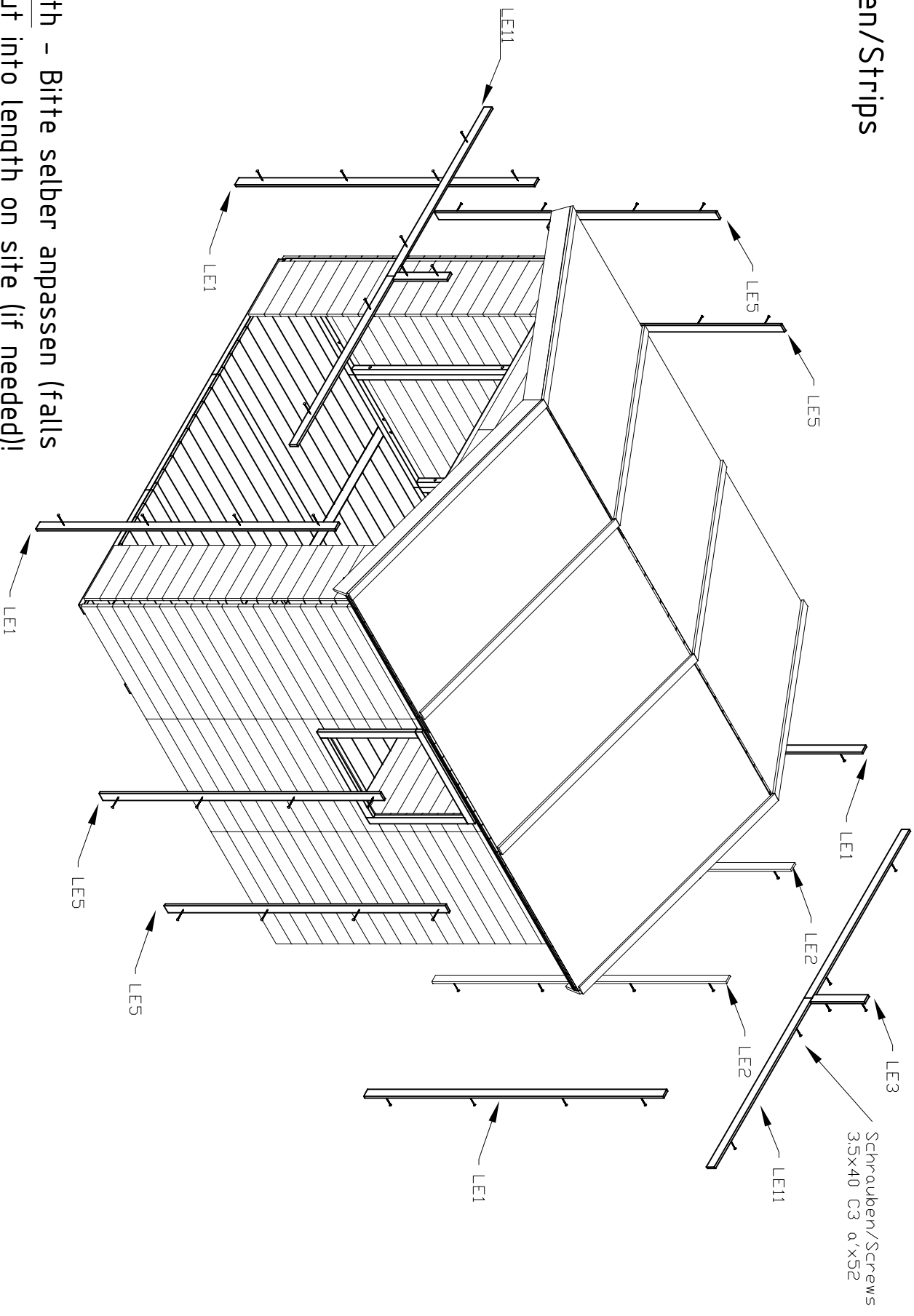

Leisten/Lath - Bitte selber anpassen (falls nötig)! / Cut into length on site (if needed)!

# Aufbau Anleitung für/Installation guide for "Hugo 230x224; 16"

## 7. Sprossen/Muntins

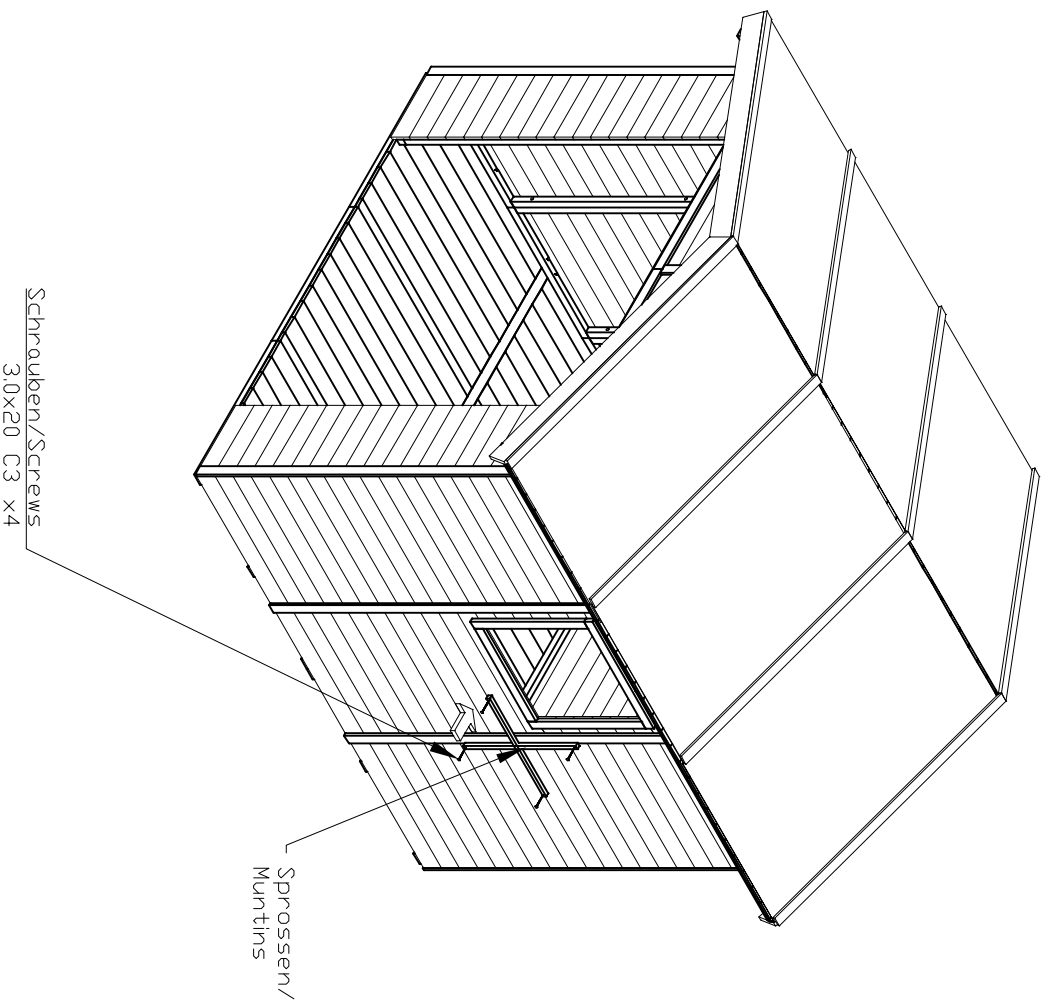

## 8.1 Tür/Door

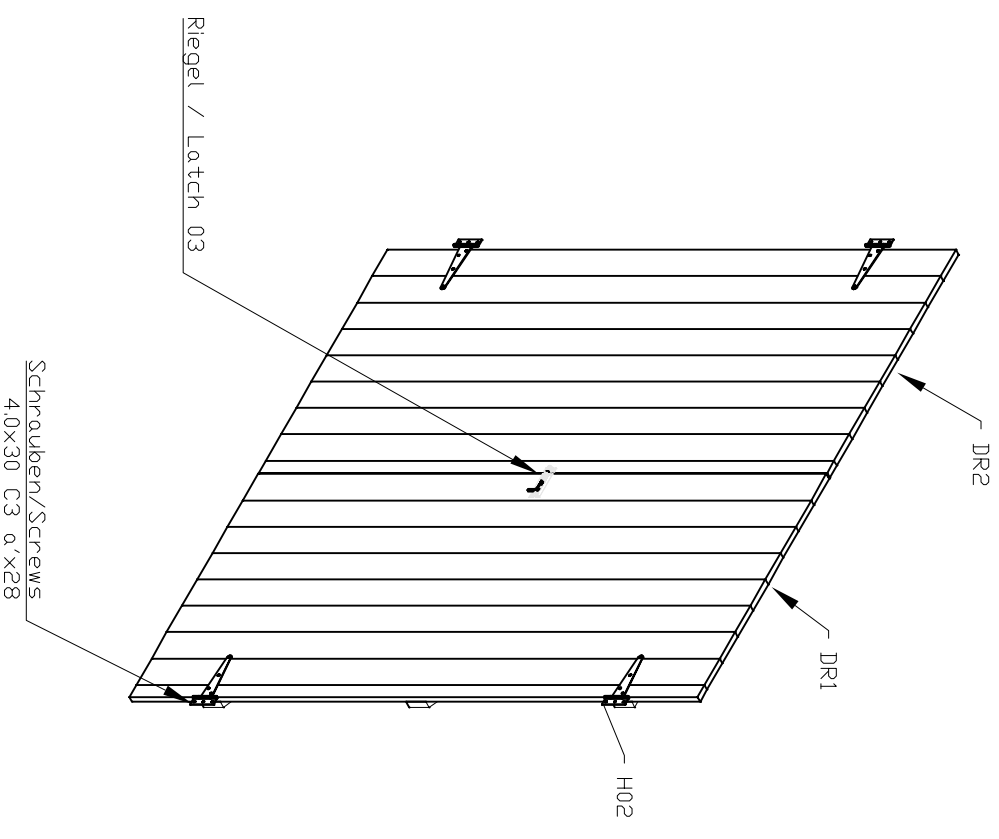

## Aufbau Anleitung für/Installation guide for "Hugo 230x224; 16"

### 8.2 Tür/Door

Unterkante der Tür bitte  
auf selbe Linie mit  
Unterkante des  
Wandelements befestigen  
/ The lower edge of the  
door should be installed  
flush with the lower edge  
of the wall panel

