

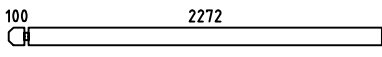

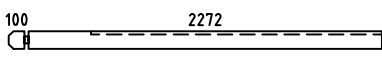





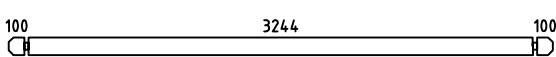
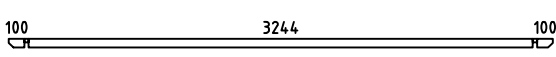
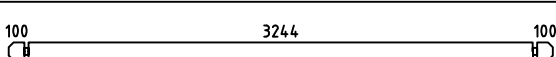
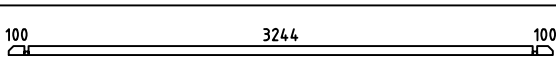
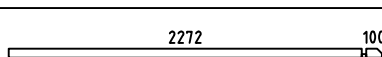
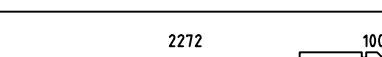
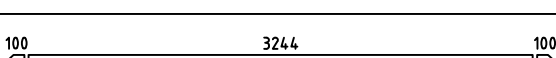
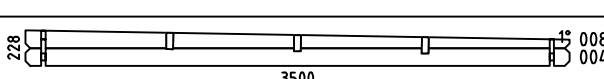
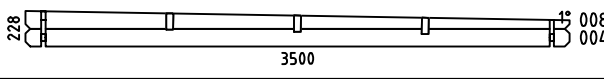

Barbara28

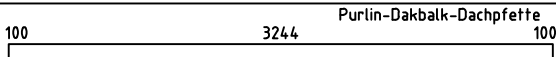
Pos	Specification-Spezifikation-Specificatie	St.	Profile (mm)	Length (mm)
001		6	28x114	2400
002		1	28x114	2400
003		25	28x114	528
004		37	28x114	3500
005		1	28x55	3500
006		1	28x114	3500
007		1	28x57	3500
009		1	28x57	2400
010		1	28x114	2400
011		1	28x114	3500
WA-1		1		
WB-1		1		
CS1	CORNICE SUPPORT - TRAGELEISTE FÜR GESIMSE-KROONLIJST STEUNEN BAR 	3	44x70	100
PR1	Purlin-Dakbalk-Dachpfette 	3	44x14.4	3500
DP-1	Roof board-Dachbrett-Dakplank 	40+1	88x18	3500
	-POST 85x85 	2		1983
L-1	Cornice-Gesimse-Kroonlijst 	2	20x250	3516
L-2	Cornice-Gesimse-Kroonlijst 	2	20x250	3540
	Diagonal for POST 85x85 	4		500
HL1	Handrail-Handlauf 	2		1820
	Storm Brace-Sturmleiste 	3	18x40	2000
U2	Uprofiil2 	2		1562
	Adjustable foot-Stellfuß+Schrauben 5x40 4stück für Post 	2		
Kood	Materjal	File	Barbara28.dwg	Leht 1/1

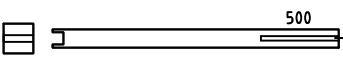
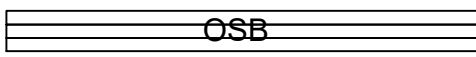
H = 1.500 m
 TOTAL: 10.52 m²

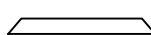
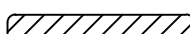
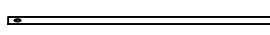
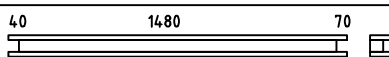

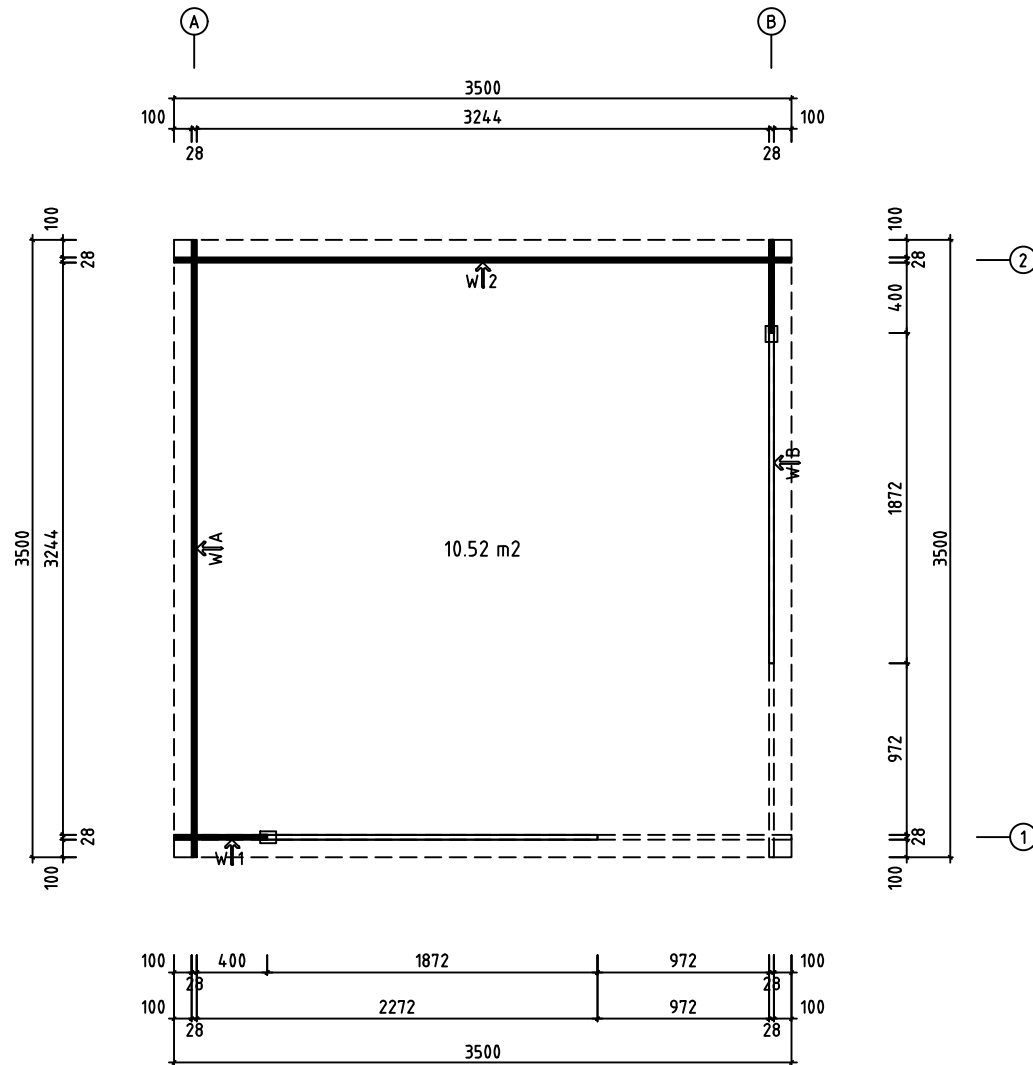
Model	Barbara28	Page	
Client		Scale	1:30
Material	28x114mm	Date	17.08.2021
Company		File	Barbara28.dwg

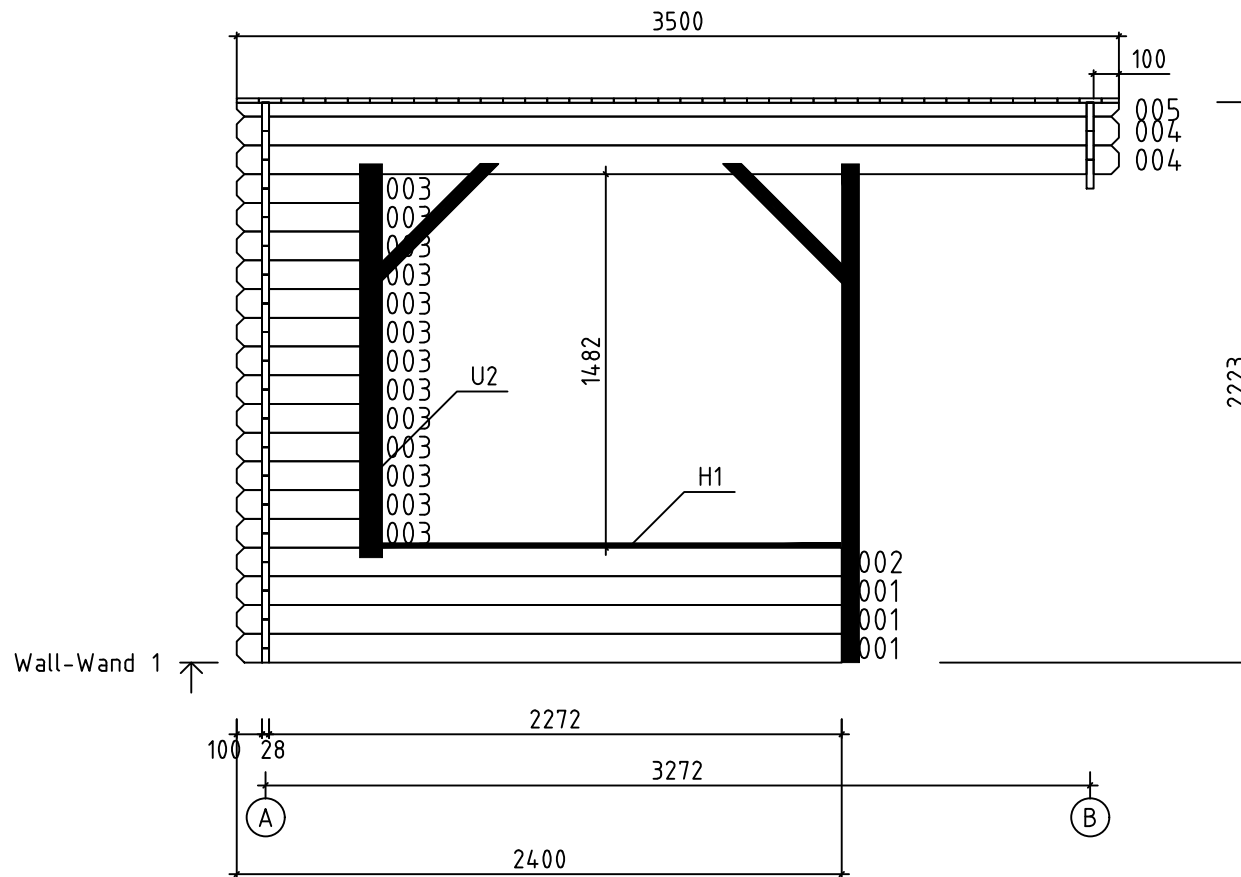

Model	Barbara28	Page	4
Client		Scale	1:30
Material	2.8x11.4	Date	17.08.2021
Company		File	Barbara28.dwg

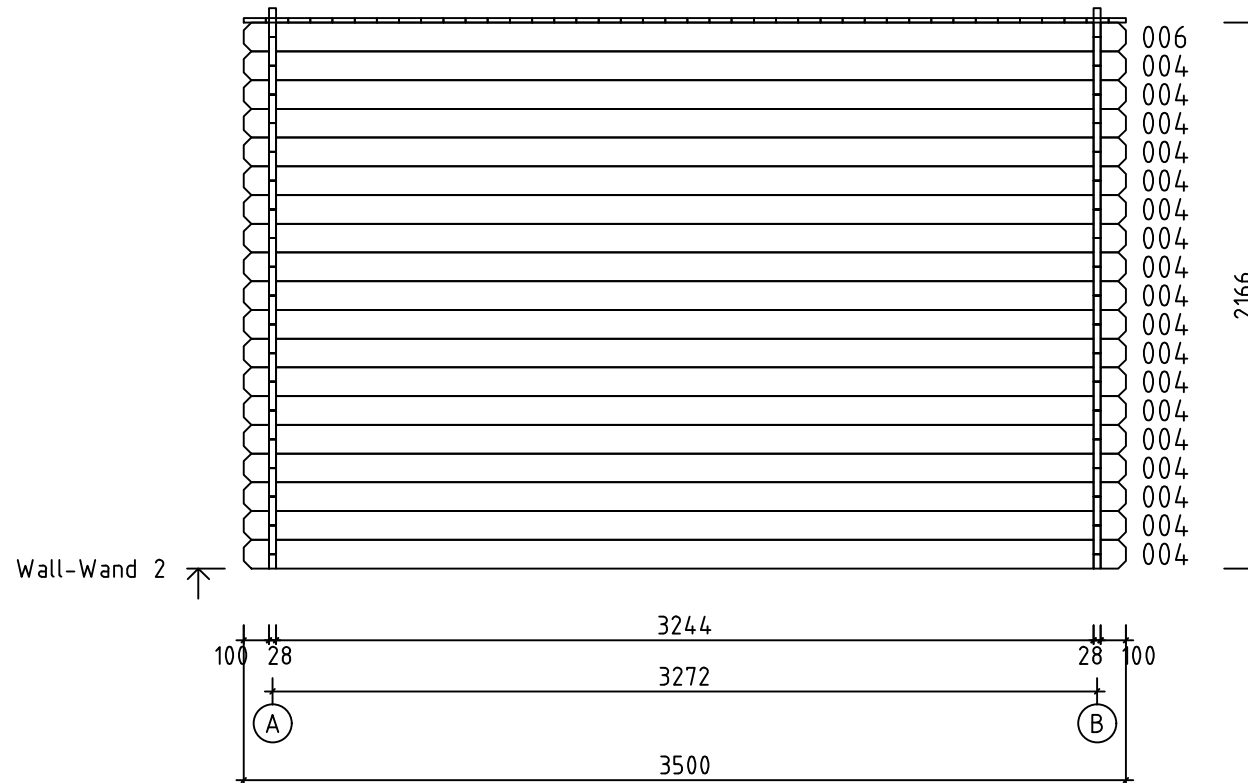

Model	Barbara28	Page	5
Client		Scale	1:30
Material	2.8x11.4	Date	17.08.2021
Company		File	Barbara28.dwg

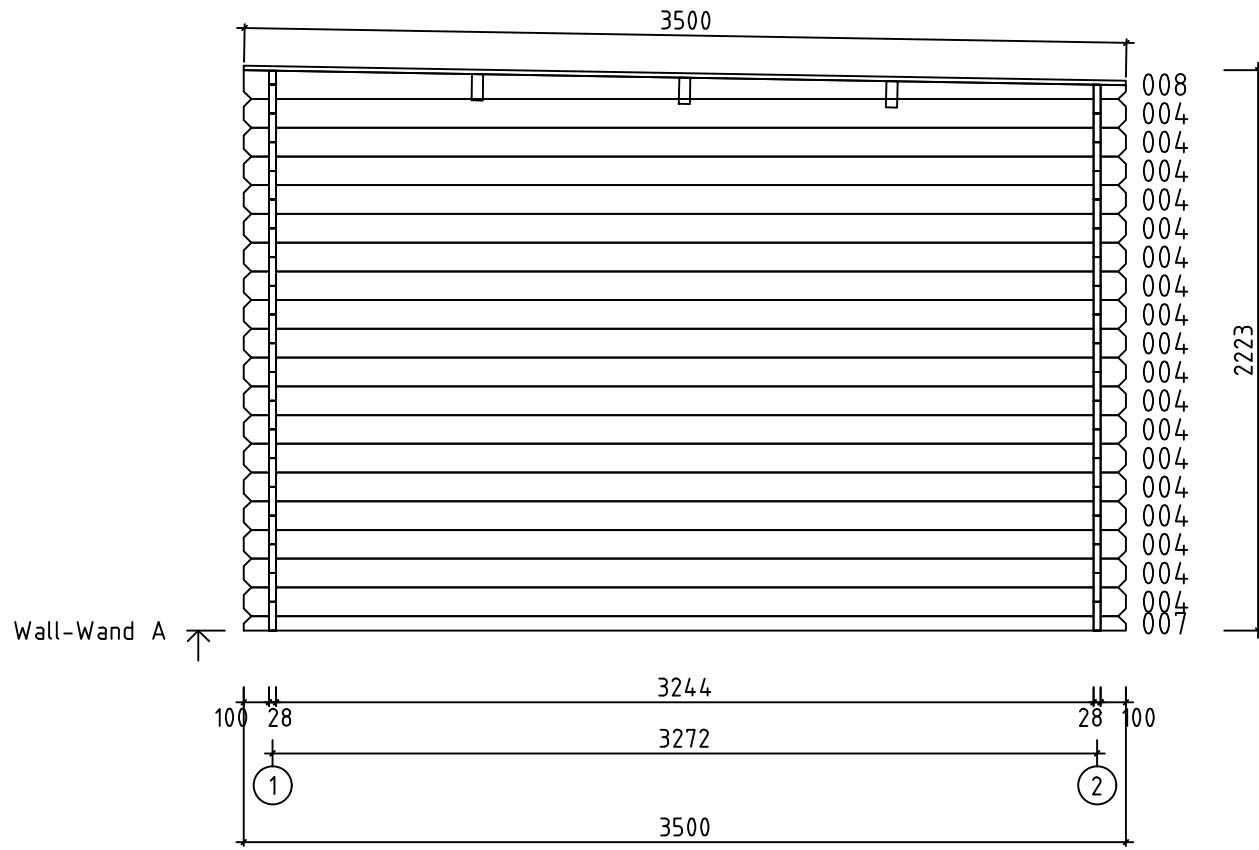

Model	Barbara28	Page	2
Client		Scale	1:30
Material	2.8x11.4	Date	17.08.2021
Company		File	Barbara28.dwg

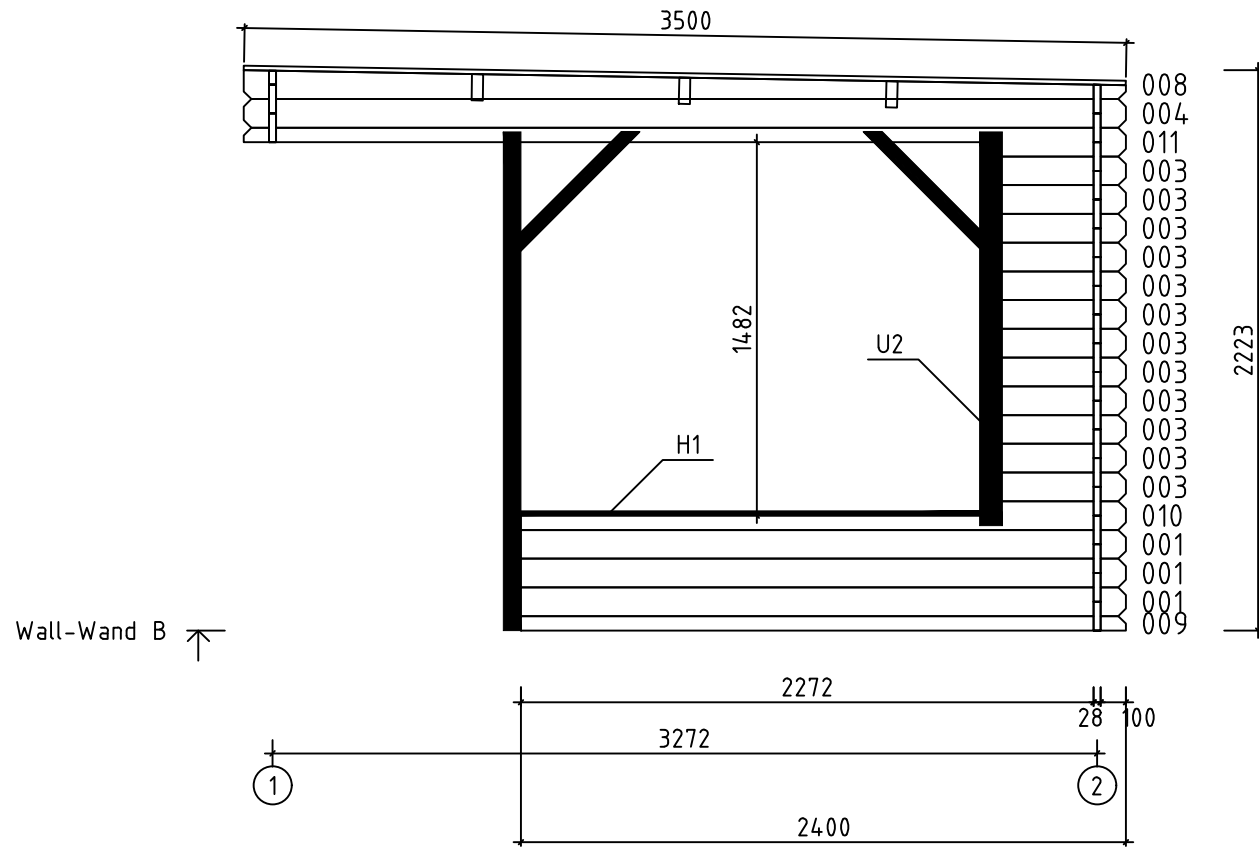

Model	Barbara28	Page	3
Client		Scale	1:30
Material	2.8x11.4	Date	17.08.2021
Company		File	Barbara28.dwg

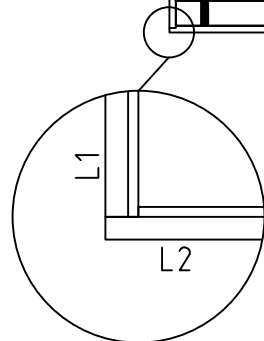
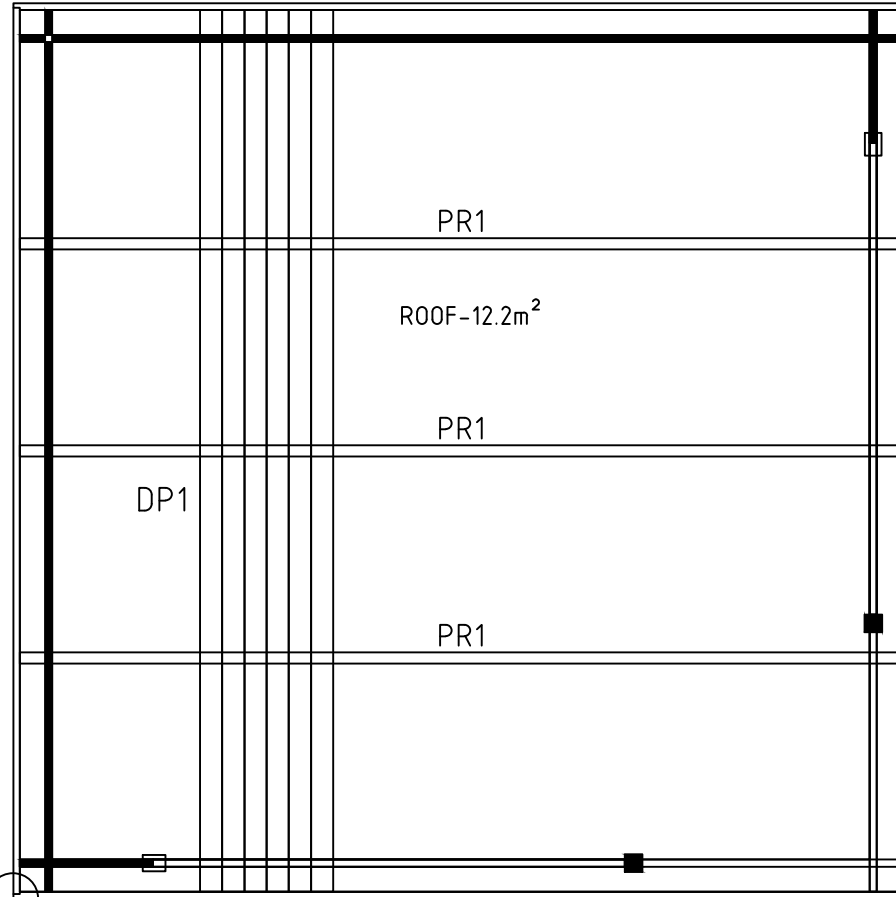

Model	Barbara28	Page	
Client		Scale	1:30
Material	28x114mm	Date	17.08.2021
Company		File	Barbara28.dwg

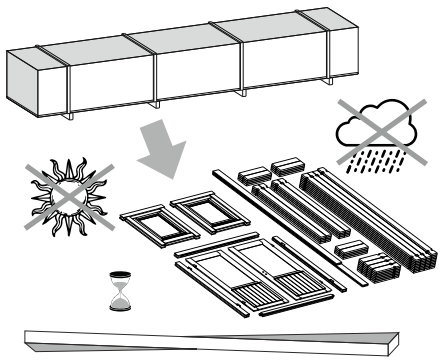

The guide is illustrative. This guide is not project specification.
 Der Leitfaden ist illustrativ. Dieser Leitfaden ist keine Projektspezifikation.
 De gids is illustratief. Deze gids is geen projectspecificatie.

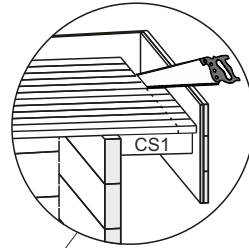
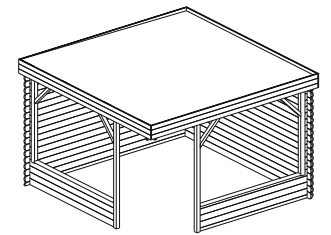

OPTIONS

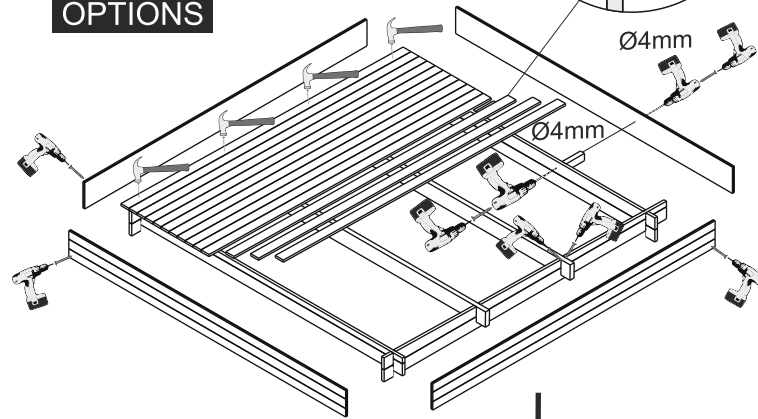

OPTIONS- STORM BRACES

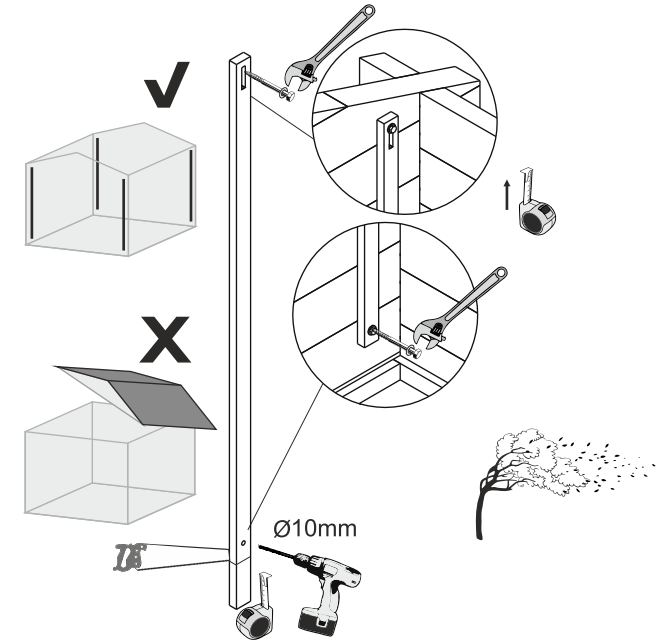

1.

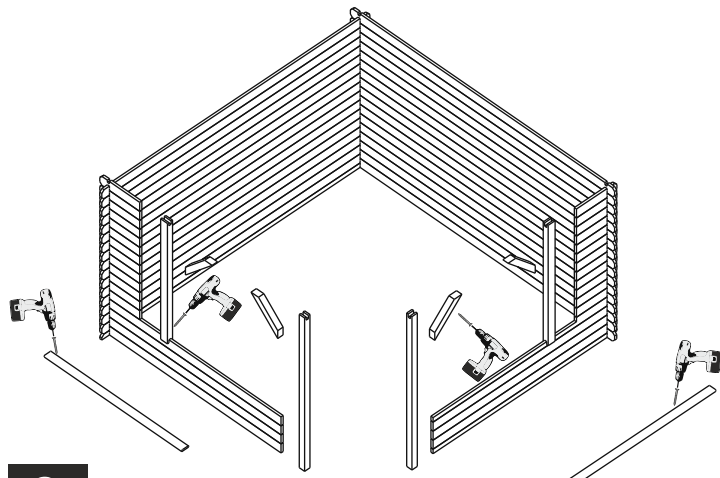
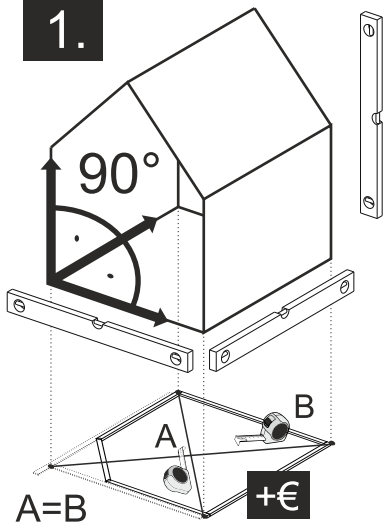

2.

