

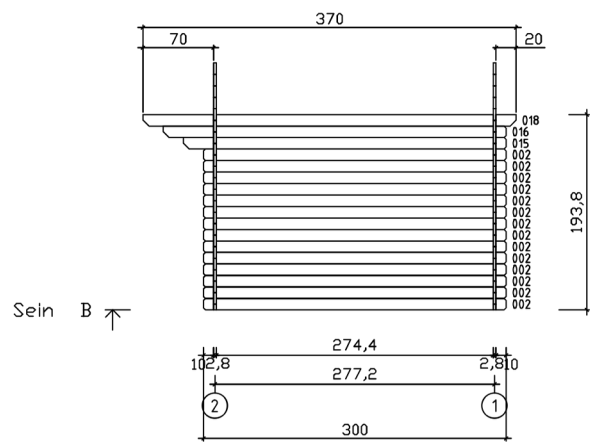

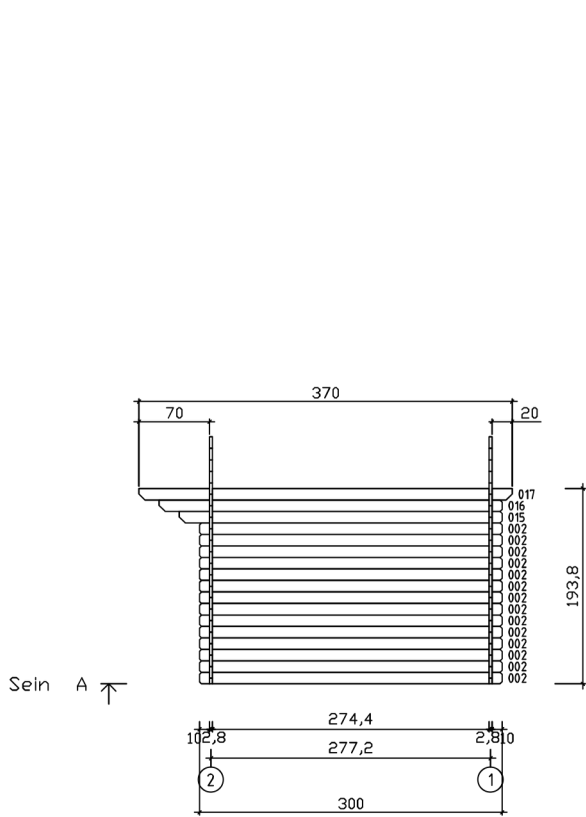

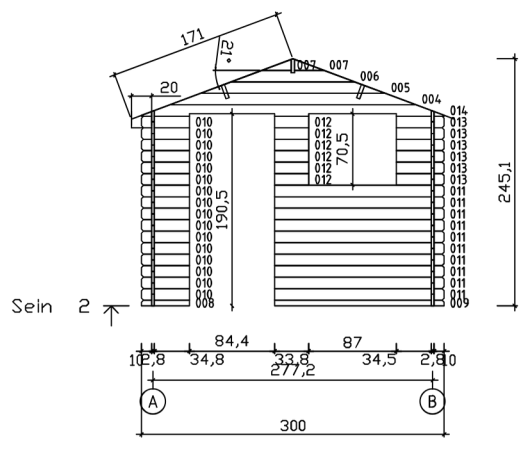

Kood	Haus Bo 28mm	Leht	1
Joonis	SEIN A	Mootkava	1:50
Materjal	2.8x11.4	Kuup.	08.10.2019
Joonestas		File	Haus Bo 28mm nu

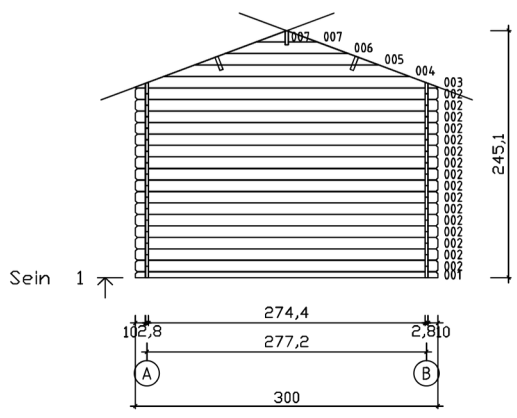

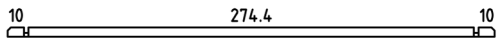
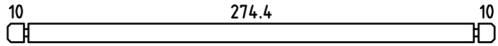
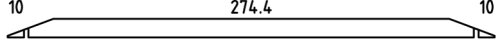
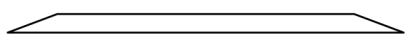
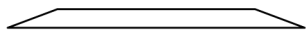
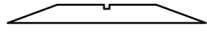
Kood	Haus Bo 28mm	Leht	1
Joonis	SEIN A	Mootkava	1:50
Materjal	2.8x11.4	Kuup.	08.10.2019
Joonestas	File Haus Bo 28mm nu		

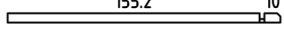

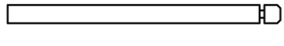

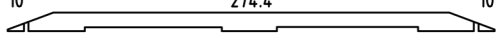
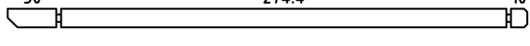
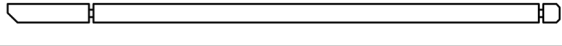
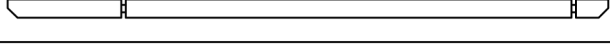
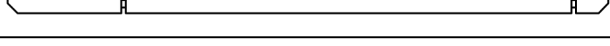
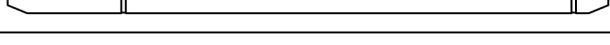
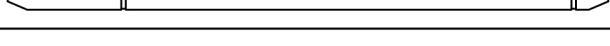



Kood	Haus Bo 28mm	Leht	3
Joonis	SEIN 1	Mootkava	1:50
Materjal	2.8x11.4	Kuup.	08.10.2019
Joonestas	File Haus Bo 28mm nu		

Pos	Joonis Haus Bo 28mm	Pcs	Profiil (cm)	Pikkus (cm)
001		1	2.8x5.7	300
002		44	2.8x11.4	300
003		1	2.8x11.4	300
004		2	2.8x11.4	243.9
005		2	2.8x11.4	182.9
006		2	2.8x11.4	122
007		4	2.8x10.8	28.8
008		1	2.8x5.7	47.6
009		1	2.8x5.7	168
010		16	2.8x11.4	47.6
011		10	2.8x11.4	168
012		6	2.8x11.4	33.8
013		6	2.8x11.4	47.3
014		1	2.8x11.4	300
015		2	2.8x11.4	320
016		2	2.8x11.4	340
017		1	2.8x11.4	370
018		1	2.8x11.4	370
PR1		2	4.3x14.5	370
PR2		1	4.3x14.5	370
	WINDOW 85x68	1		
	DOOR 83x188	1		

Kood Haus Bo 28mm

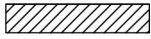
Materjal

File Haus Bo 28mm nurgadetail.dwg

Pos	Drawing Haus Bo 28mm		Pcs	Profile (cm)	Length (cm)
019	ROOF BOARDS/DACHBRETTER/VOLIGE		66 54	11.2x1.6 13.7x1.6	171 171
020	ROOF EDGE REINFORCEMENT/TRAUFENLEISTE/TASSEAU		2	2.6x3.2	370
021	ROOF SIDE BOARDS/TRAUFENBRETT/PLANCHE DE RIVE		2	1.8x6	370
022	FASCIA BOARD/GIEBELBLENDE/PLANCHE DE RIVE (FACADE)		4	1.8x12.0	176
023	FASCIA BOARD/GIEBELBLENDE/PLANCHE DE RIVE (FACADE)		4	1.8x6.0	176
024	DIAMOND/RAUTE/DIAMANT		2	1.8x12	
Kood Haus Bo 28mm		Materjal	File Haus Bo 28mm nurgelichting.dwg		

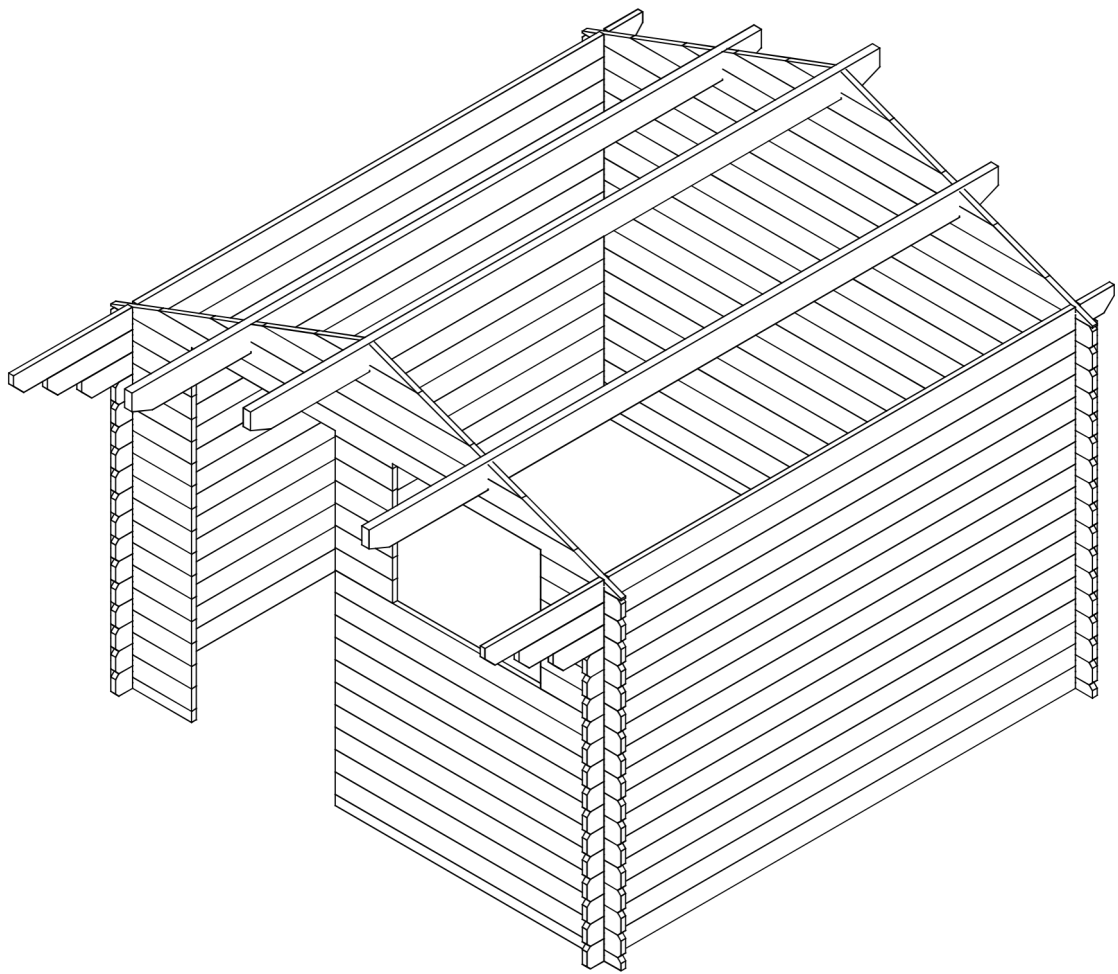

# COUNTRYWOOD

*De weergegeven opbouw instructies en maatvoering zijn gebaseerd op het standaardmodel van deze blokhut. Omdat wij samenwerken met meerdere producenten, kunnen lichte afwijkingen voorkomen in constructie, detaillering, houtbewerking of afmetingen. Bij iedere levering wordt een geprinte versie van de opbouw instructies meegeleverd. Deze instructies maken onderdeel uit van de levering en zijn leidend bij montage en uitvoering. Aan deze algemene, online of vooraf verstrekte versie kunnen geen rechten worden ontleend. Eventuele afwijkingen geven geen recht op schadevergoeding, ontbinding of andere aanspraken, tenzij schriftelijk anders overeengekomen.*