

Name	Maja TU 240x320+SD/28		
Zeichnung/Drawing	3D		
Profil/Profile	2.8x11.4	Datum/Date	10.12.2018

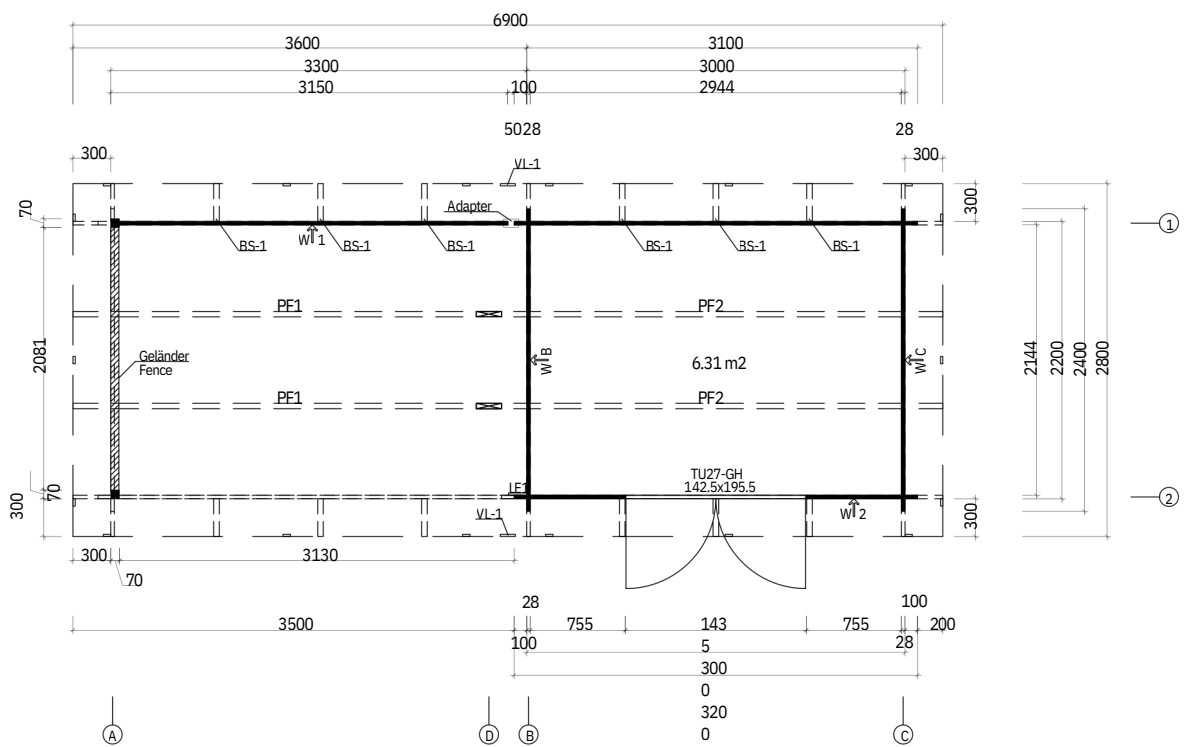

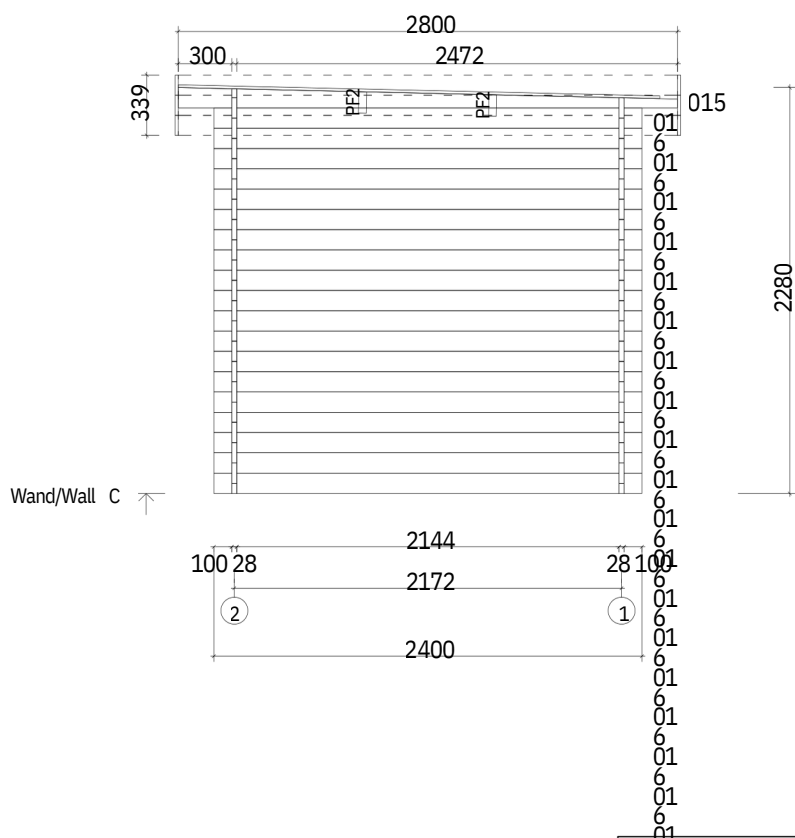





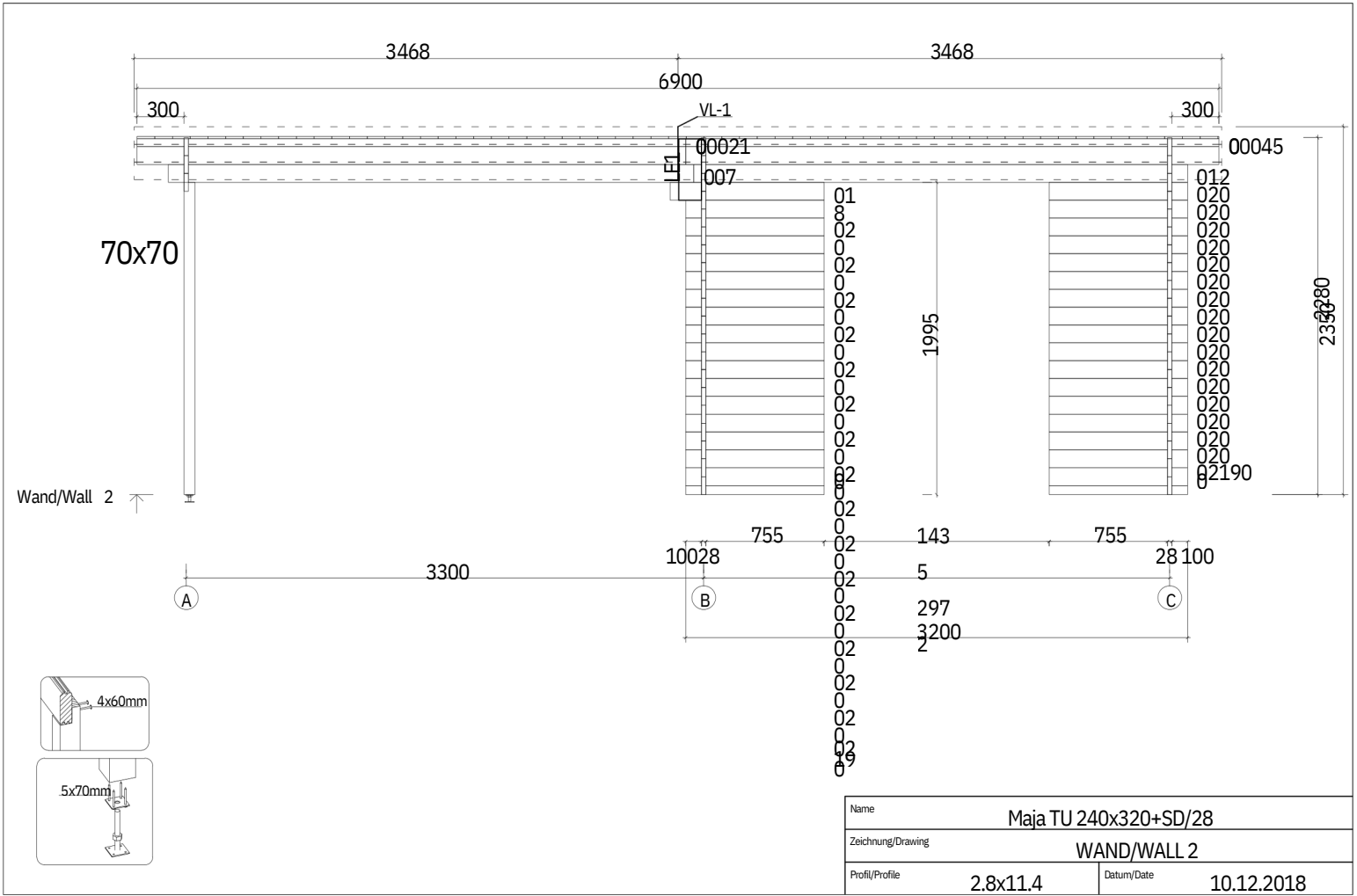

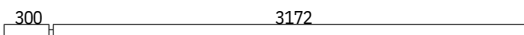
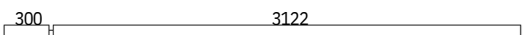
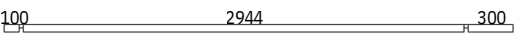
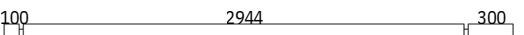
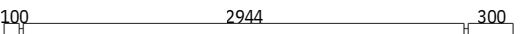
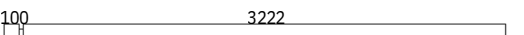
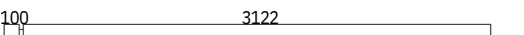
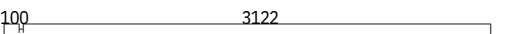
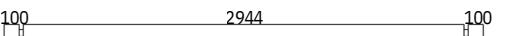
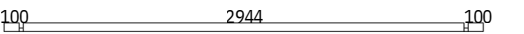
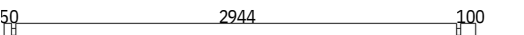
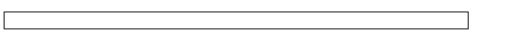
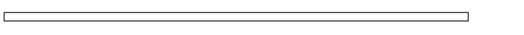
Name	Maja TU 240x320+SD/28	
Zeichnung/Drawing	Grundplan; Plan	
Profil/Profile	2.8x11.4	Datum/Date
		10.12.2018



Name	Maja TU 240x320+SD/28	
Zeichnung/Drawing	WAND/WALL C	
Profil/Profile	2.8x11.4	Datum/Date 10.12.2018

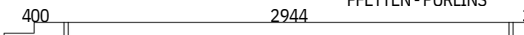
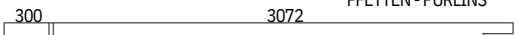

Pos	Teileliste/Specification Maja TU 240x320+SD/28		Stck. Pcs.	Profil Profile (mm)	Länge Length (mm)
001		3172	1	28x50	3500
002		3172	1	28x114	3500
003		3122	1	28x114	3450
004		2944	1	28x50	3400
005		2944	1	28x114	3400
006		2944	1	28x114	3400
007		3222	1	28x114	3350
008		3122	1	28x114	3250
009		3122	1	28x114	3250
010		2944	18	28x114	3200
011		2944	1	28x57	3200
012		2944	1	28x114	3150
013			16	28x114	3100
014			1	28x57	3100
015		2144	3	28x114	2800
016		2144	39	28x114	2400
017		2144	1	28x114	2400
018		755	1	28x114	983
019		755	2	28x57	883
020		755	33	28x114	883
LE1	LEISTE - LATH		1	145x18	392
PF2		2944	2	44x145	3700
PF1		3072	2	44x145	3400
	DACHBRETTNER - ROOF BOARDS		62+1	113x16	2700
A28-1	ADAPTER 28		1	64x120	2225
Kood	Maja TU 240x320+SD/28	Materjal	File		Leht 1/2

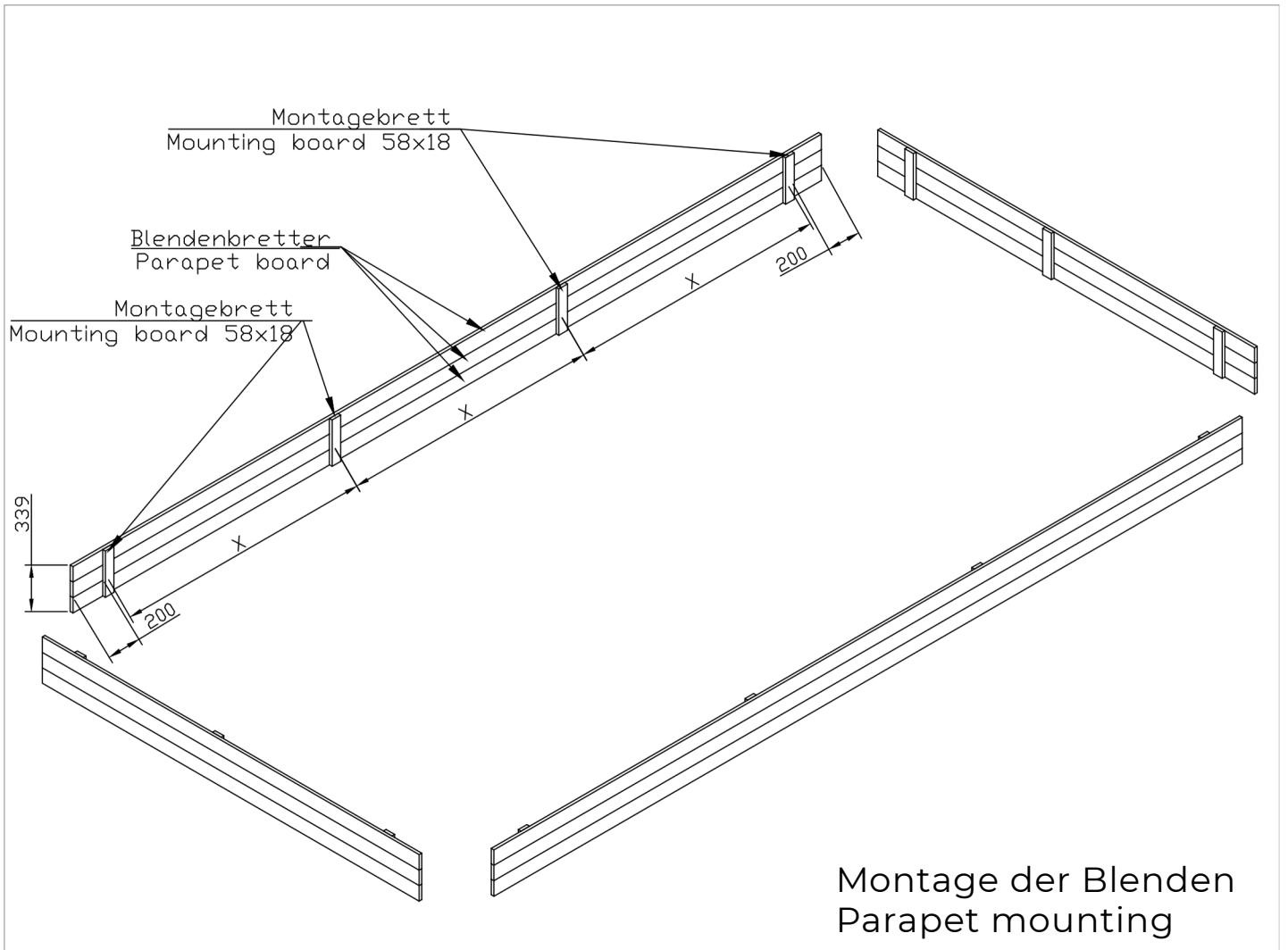

Pärinite ühendamine / Verbinden der Pfetten / Connecting purlins

1

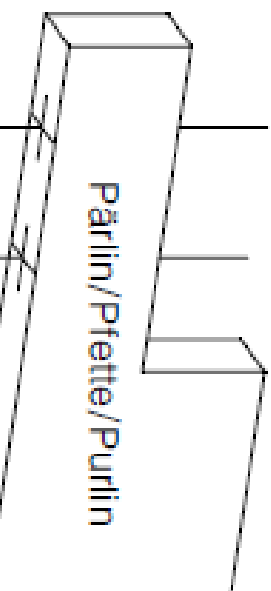

Märgige kruvide asukohad /
Markieren Sie die empfohlenen
Schraubenpositionen /
Mark the suggested positions
for screws

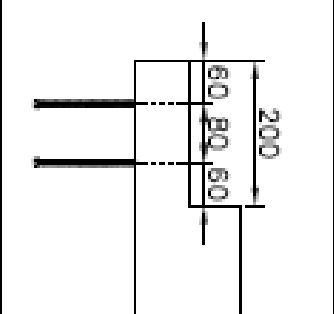

2

Keerake kruvid poole ulatuses sisse.
(Vaja tõhbe Assy AW30 või Torx T30 otsikut) ⚙
Drehen Sie die Schrauben bis zur Hälfte
seiner Länge ein.
(Für diese Schrauben benötigen Sie einen
Assy AW30 oder Innentorx T30
Schraubereinsatz) ⚙
Turn the screws up
until the first half.
(These screws require Assy AW30
or Torx T30 driver bit) ⚙

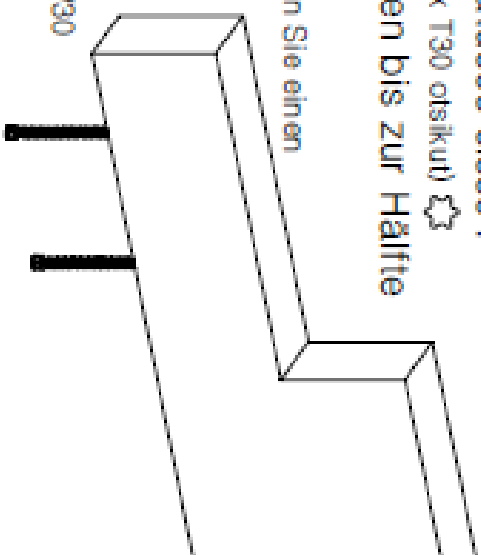

3

Hoiata ühendavad pärinid tihedalt koos /
Setzen Sie die Enden der Balken zusammen /
Keep purlins tight together

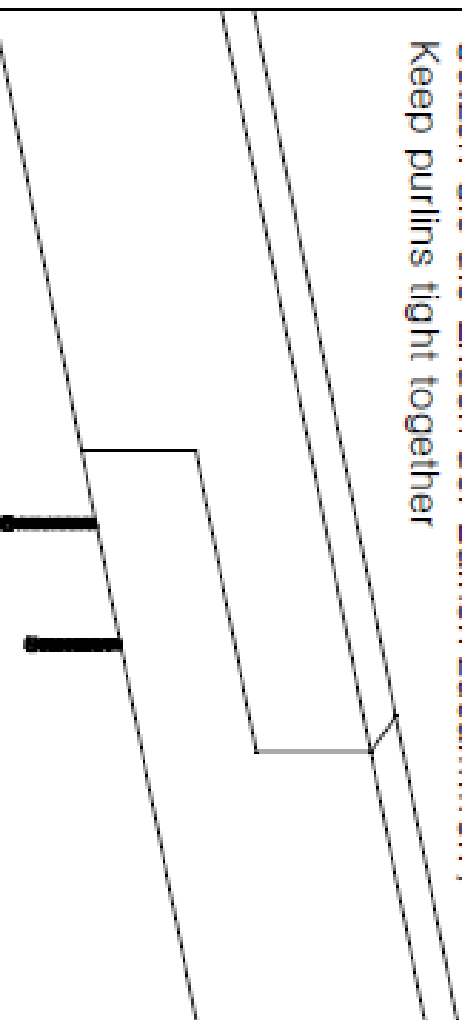

4

Keera kruvid lõpuni sisse /
Drehen Sie die Schrauben dann ganz ein /
Turn the screws up until the end

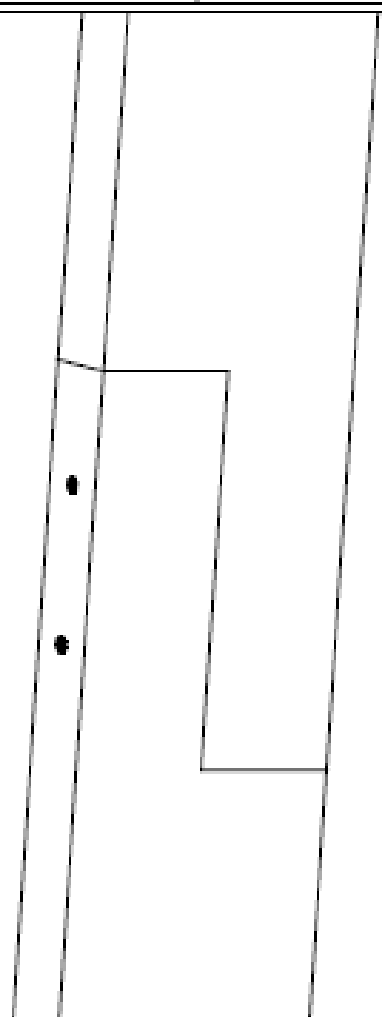

Cutting support post / Schneiden der Stützpfosten



- * Adjustment space for post support should be at least 50mm.
- * Einstellraum für die Pfostenstütze muss mindestens 50mm sein.

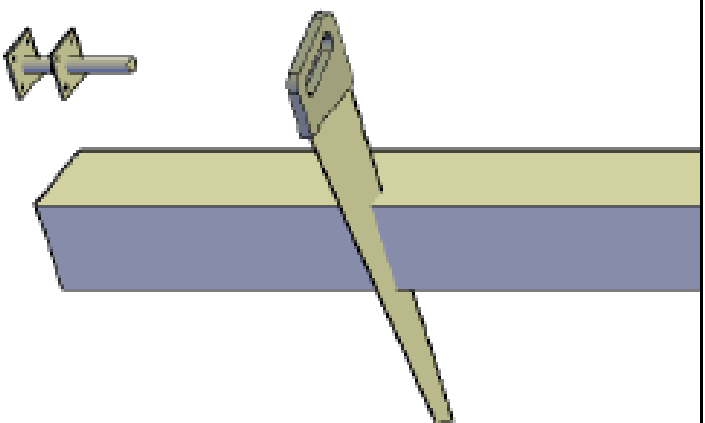

- * Support post has extra length for various conditions. Must be sawn to suitable length on spot considering local conditions.
- * Stützpfosten hat extra Länge für verschiedene Bedingungen. Muss vor Ort unter Berücksichtigung der örtlichen Gegebenheiten zu einer geeigneten Länge gesägt werden.

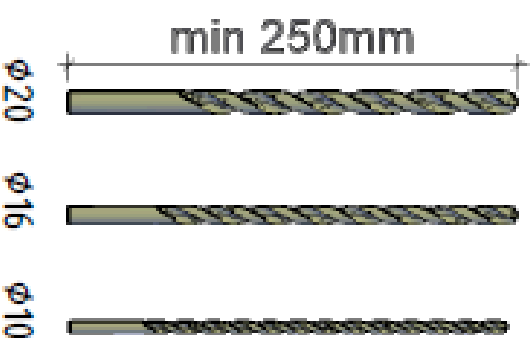
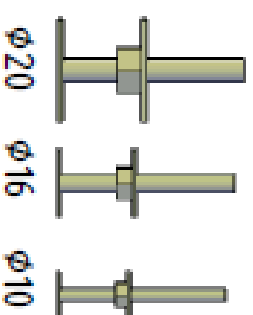

- * In some cases you need to drill a new hole for a post support. Find a matching drill bit.
- * In einigen Fällen müssen Sie ein neues Loch für die Pfostenstütze bohren. Finden Sie hier den passenden Bohrer.

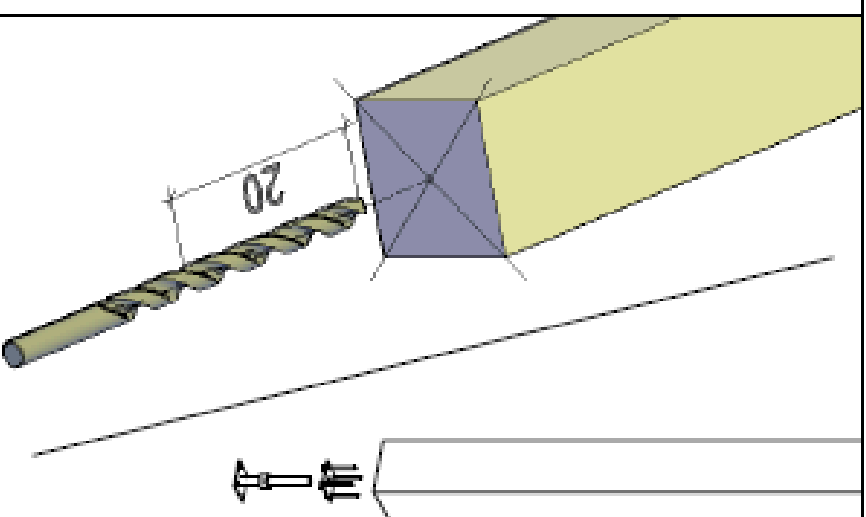

- * Mark the center of the post and drill a new 20cm deep hole. Continue building.
- * Markieren Sie die Mitte des Pfostens und bohren Sie ein neues 20cm tiefes Loch. Danach mit Aufbau weiter machen.

Ukse montaaž / Tür montage / Door assembly
28-40mm (GH)

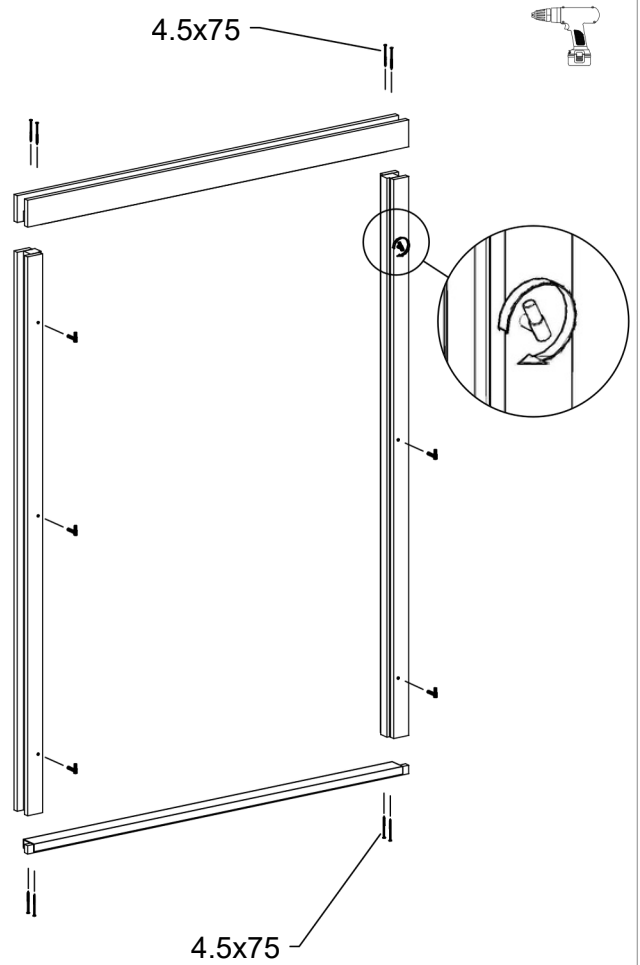
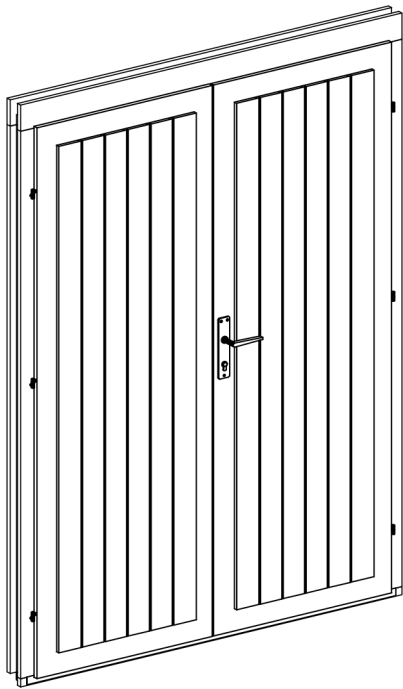

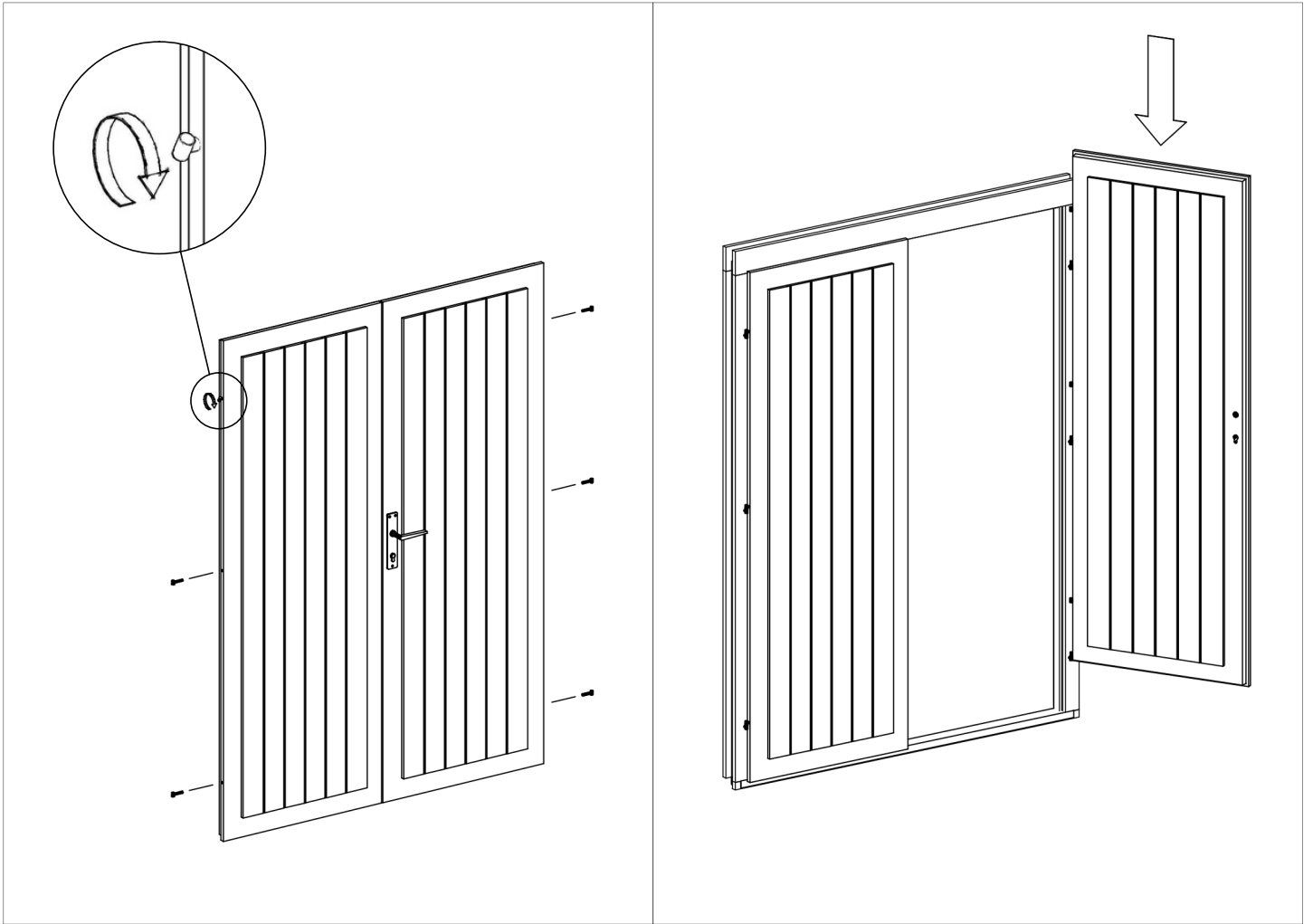

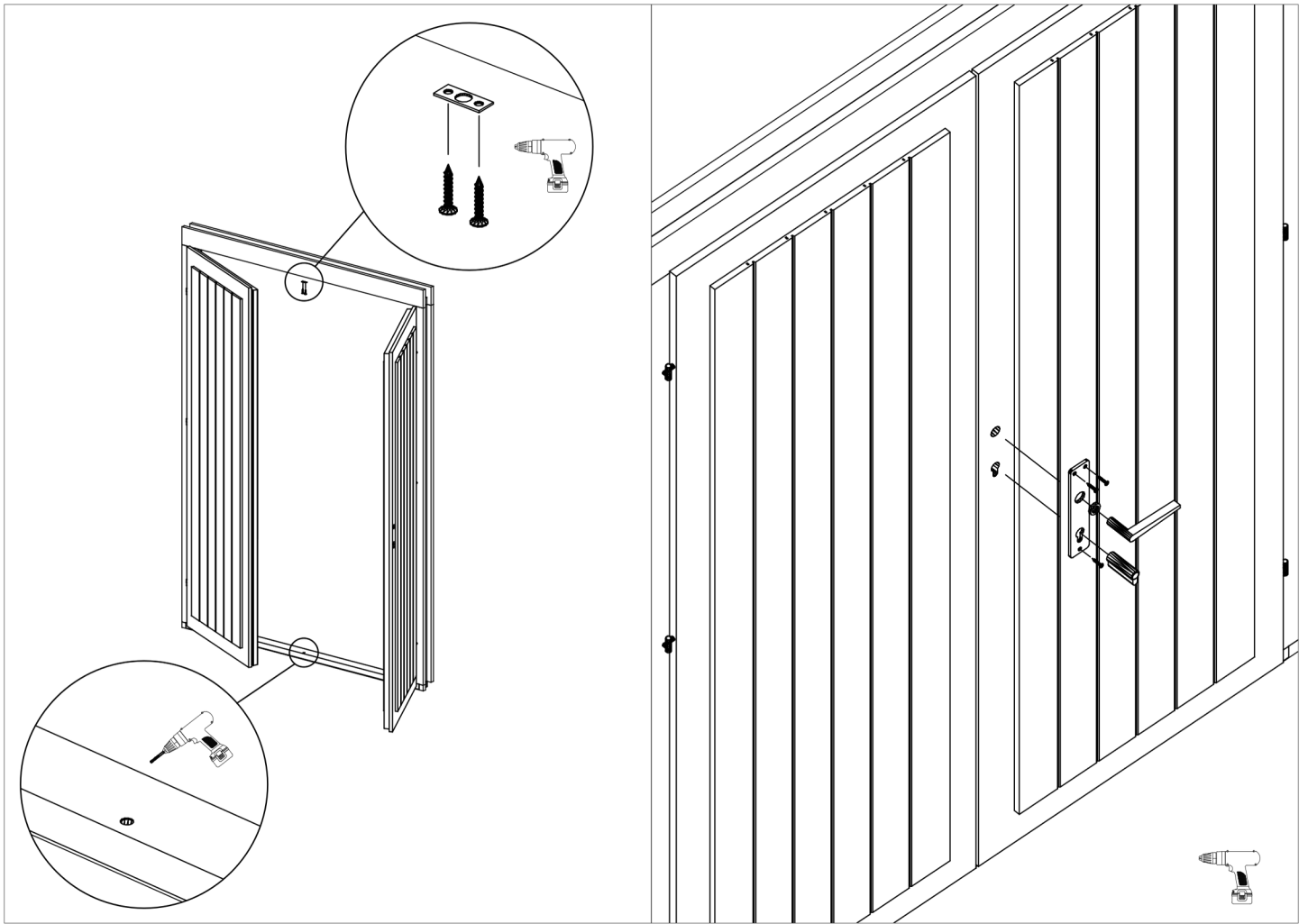

COUNTRYWOOD

De weergegeven opbouw instructies en maatvoering zijn gebaseerd op het standaardmodel van deze blokhut. Omdat wij samenwerken met meerdere producenten, kunnen lichte afwijkingen voorkomen in constructie, detaillering, houtbewerking of afmetingen. Bij iedere levering wordt een geprinte versie van de opbouw instructies meegeleverd. Deze instructies maken onderdeel uit van de levering en zijn leidend bij montage en uitvoering. Aan deze algemene, online of vooraf verstrekte versie kunnen geen rechten worden ontleend. Eventuele afwijkingen geven geen recht op schadevergoeding, ontbinding of andere aanspraken, tenzij schriftelijk anders overeengekomen.